

OPERATING INSTRUCTIONS & SERVICE MANUAL

SOLID-STATE STEREO AMPLIFIER

SANSUI AU-999



Sansui

SANSUI ELECTRIC CO., LTD.

Congratulations on joining the thousands of proud, satisfied owners of quality stereo components from Sansui.

The AU-999 is the most advanced professional control amplifier ever manufactured by Sansui. Designed specifically for an ardent audiophile like you, it features the refined dull black panels common to all AU series professional control amplifiers from Sansui.

The preamplifier section is constructed of carefully selected low-noise PNP silicon transistors, while the power amplifier section features direct-coupled circuits specially developed with the improvement of tone quality in mind. Together, they permit the AU-999 to deliver a full 180 watts (4Ω) in music power output with unprecedentedly good tone quality.

The AU-999 is lavishly endowed with accessory circuits. These include a Tone Selector circuit, an improved form of the Triple Tone Control circuit that offers a choice in selecting the critical frequencies of tone control; a Speaker Selector which permits connecting three sets of speaker systems; a Balance Check Switch which simplifies the job of adjusting for optimum balance of the right and left channel sound volumes; facilities to connect two phonographs and two tape decks; and a tape reprint circuit which makes it possible to copy a recorded tape by utilizing two tape decks. Special provisions have also been made to permit the amplifier to be built up into an electronic crossover stereo system and permit comparing such a system with a standard stereo setup.

From the superior performance characteristics to the careful finish of control knobs, Sansui's tradition of quality is evident. Packed with the most advanced circuits throughout, the AU-999 comes to you with the full confidence and guarantee of the manufacturer.

It is now up to you to read the contents of this manual carefully before setting out to use it, so you may operate it correctly and obtain the maximum performance it is capable of offering for many years to come.

CONTENTS

SWITCHES AND CONTROLS.....	3, 4, 5, 6
OPERATIONS	7, 8
—SPEAKER CONNECTION	
—RECORD PLAYING	
OPERATIONS	9, 10
—RADIO RECEPTIONS	
—MICROPHONES	
OPERATIONS	11, 12
—TAPE PLAYBACK	
—TAPE RECORDING	
ELECTRONIC CROSSOVER SYSTEM	13, 14
MAINTENANCE	15, 16, 17, 18
ACCESSORIES	18
SPECIFICATIONS	19
CHARACTERISTICS	20
TROUBLESHOOTING CHART	21, 22
CUSTOM MOUNTING.....	23, 24
DISASSEMBLY PROCEDURE	25
BLOCK DIAGRAM/LEVEL DIAGRAM.....	26
ALIGNMENT	27, 28
—TEST POINTS	
—MAIN AMP. SECTION OUTPUT BALANCE/CURRENT ADJUSTMENT	
PRINTED CIRCUIT BOARDS AND PARTS LIST	29, 30, 31, 32, 33, 34
OTHER PARTS	35, 36
OTHER PARTS AND THEIR POSITION ON CHASSIS	37, 38

SWITCHES AND CONTROLS

Source Selector Indicator

Power Indicator

The Power indicator is lit when the Power switch is turned on. It remains lit while the amplifier is on.

Speakers Switch

Three pairs of speakers can be connected to the amplifier. You can install the main set of speakers (System A) in your listening room and additional speakers (System B and C) in the same room or remotely in other rooms of your home. With the P-M connector removed, the amplifier and the speakers connected to the System C outputs can be used as a component of the Electronic Crossover System.

OFF: All speakers connected to the amplifier are muted for private listening with headphones connected to the Phones jack.

SYSTEM A: Selects the speakers connected to the System A terminals.

SYSTEM B: Selects the speakers connected to the System B terminals.

SYSTEM A+B: Selects the A and B speakers simultaneously.

SYSTEM C: Selects the speakers connected to the System C terminals.

Power Switch

Power is applied to the amplifier when the Power switch is set in its up position. This switch controls any other components connected to the upper two AC outlets on the rear panel.

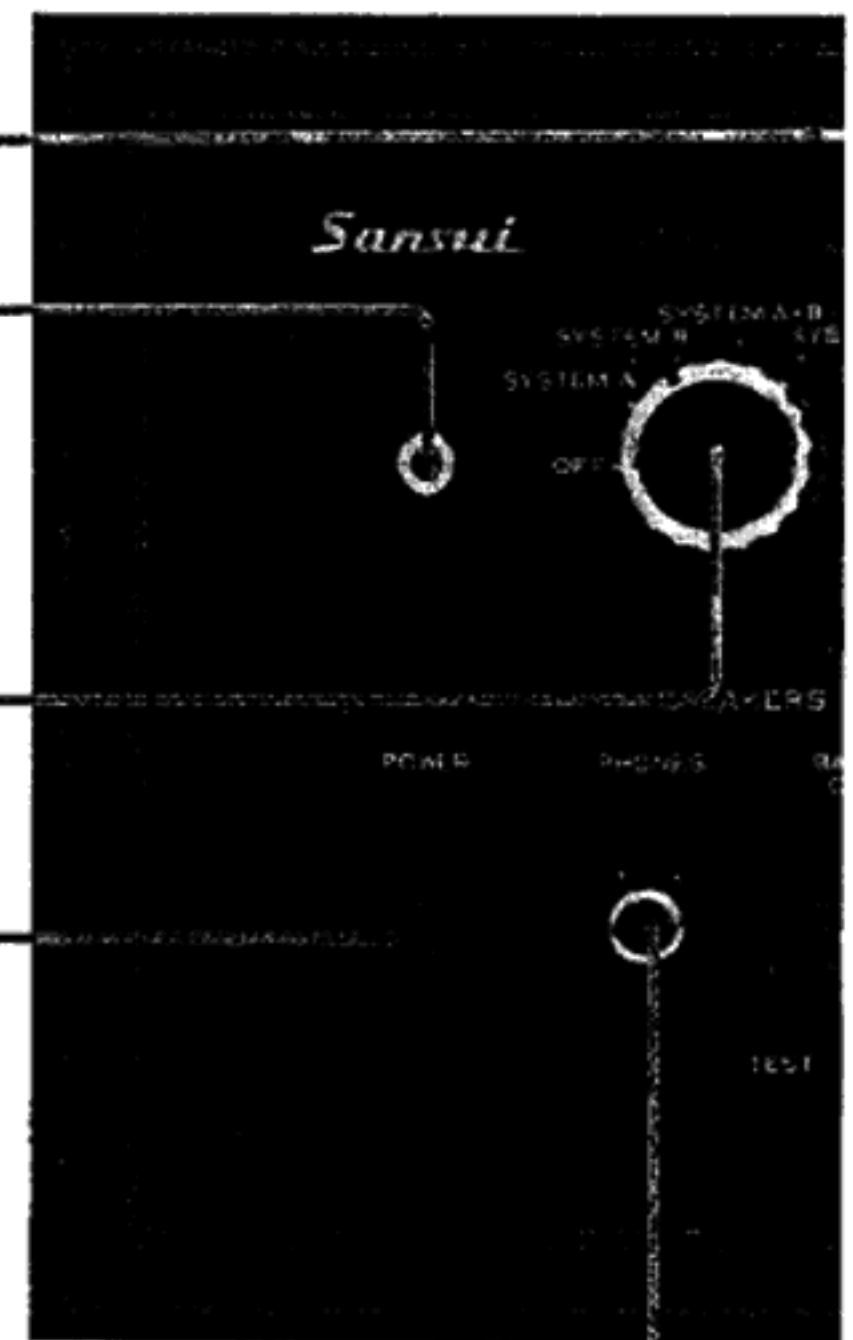

Headphones Jack

Plug a stereo headset into this jack for private listening or monitoring. This jack will accept any standard stereo phone plug, but a dynamic headset is recommended.

Balance Check Switch

This switch is used to check whether the sound levels from both right and left speakers are equal. Turn the Mode switch to any MONO position; turn all Tone Selector switches to DEFEAT; set the Balance Check switch to the down or TEST position; and adjust the Balance control so that the sound levels from both speakers are minimized. When not in use, make sure this switch is in its up position.

Note: Headphones cannot be controlled by this switch. Balance unequal sound levels from both speakers as described above, and then use the headphones.

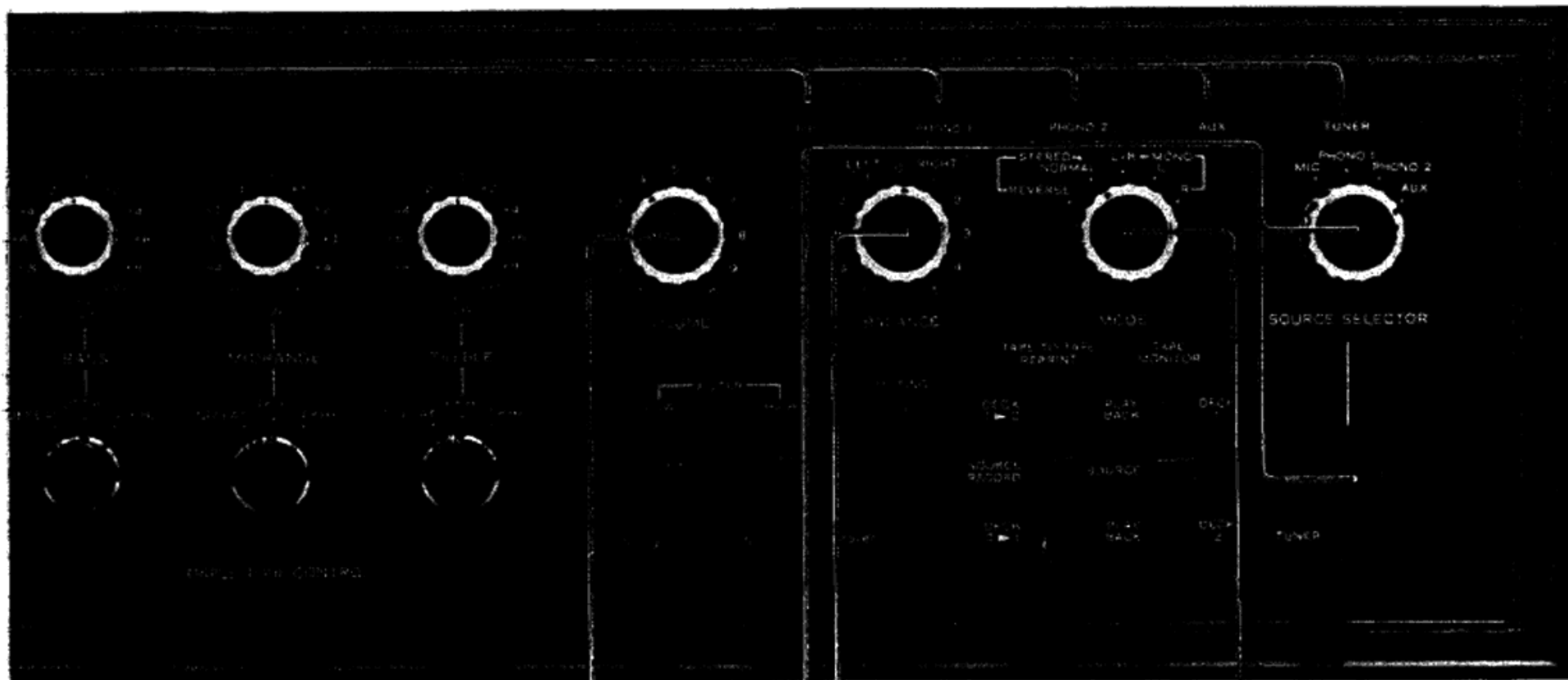

Volume Control

This control adjusts the over-all sound level of both channels. Turn it clockwise, and the volume is increased; and vice versa.

Source Selector Switch

This switch selects from among the various program sources connected to the input jacks on the rear panel of the amplifier.

MIC: Selects a 50k Ω microphone or microphones connected to the MIC inputs.

PHONO 1: Selects a record player having a 50 k Ω cartridge connected to the PHONO 1 inputs.

PHONO 2: Selects a record player having a 30, 50 or 100 k Ω cartridge connected to the PHONO 2 inputs.

AUX: Selects other components connected to the AUX inputs.

TUNER: To select a tuner connected to the TUNER inputs, set the lever to its down or TUNER position. When not in use, it must be in its up position.

Mode Switch

STEREO REVERSE: Use this position if the channels of a stereo program are reversed. The Mode switch connects the left input to the right speaker and the right input to the left speaker.

STEREO NORMAL: Use this position if the stereo program is normal. The Mode switch connects the left input to the left speaker and the right input to the right speaker.

MONO L+R: The Mode switch in this position connects the left and right inputs to both speakers.

MONO L: The Mode switch in this position connects the left input to both speakers.

MONO R: The Mode switch in this position connects the right input to speakers.

Balance Control

This control adjusts for equal sound from both left and right channels to compensate for slight imperfections in program material, variations in speaker output, and the vagaries of room acoustics.

SWITCHES AND CONTROLS

Treble Control

This control determines the amount of treble tone in both channels. When the marker is centered at the 0 position, the response curve is flat. The control emphasizes the treble tone by 2 dB per step as it is turned clockwise. To decrease the treble loudness, turn it counterclockwise.

Midrange Control

This control determines the amount of midrange in both channels. When the marker is centered at the 0 position, the response curve is flat. The control emphasizes the midrange by 1 dB per step as it is turned clockwise. To decrease the midrange loudness, turn it counterclockwise.

Bass Control

This control determines the amount of bass tones in both channels. When the marker is centered at the 0 position, the response curve is flat. The control emphasizes the bass tone by 2 dB per step as it is turned clockwise. To decrease the bass loudness, turn it counterclockwise.

Bass Tone Selector

This switch selects the frequency at which the Bass control begins to cut or boost.

DEFEAT: Use this position for flat response at low frequencies.

200 Hz: The Bass control begins to cut or boost the bass tone at 200 Hz.

400 Hz: The Bass control begins to cut or boost the bass tone at 400 Hz.

Midrange Tone Selector

This switch selects the frequency at which the Midrange control begins to cut or boost.

DEFEAT: Use this position for flat response at mid-frequencies.

1 kHz: The Midrange control begins to cut or boost the midrange at 1000 Hz.

2 kHz: The Midrange control begins to cut or boost the midrange at 2000 Hz.

Treble Tone Selector

This switch selects the frequency at which the Treble control begins to cut or boost.

DEFEAT: Use this position for flat response at high frequencies.

6 kHz: The Treble control begins to cut or boost the highs at 6000 Hz.

3 kHz: The Treble control begins to cut or boost the highs at 3000 Hz.

Low Filter

Turntable rumble and other low-frequency noises are reduced by setting the Low Filter switch to the ON position.

High Filter

Surface noise from old or worn records, tape hiss and other high-frequency noises are reduced by setting the High Filter switch to the ON position.

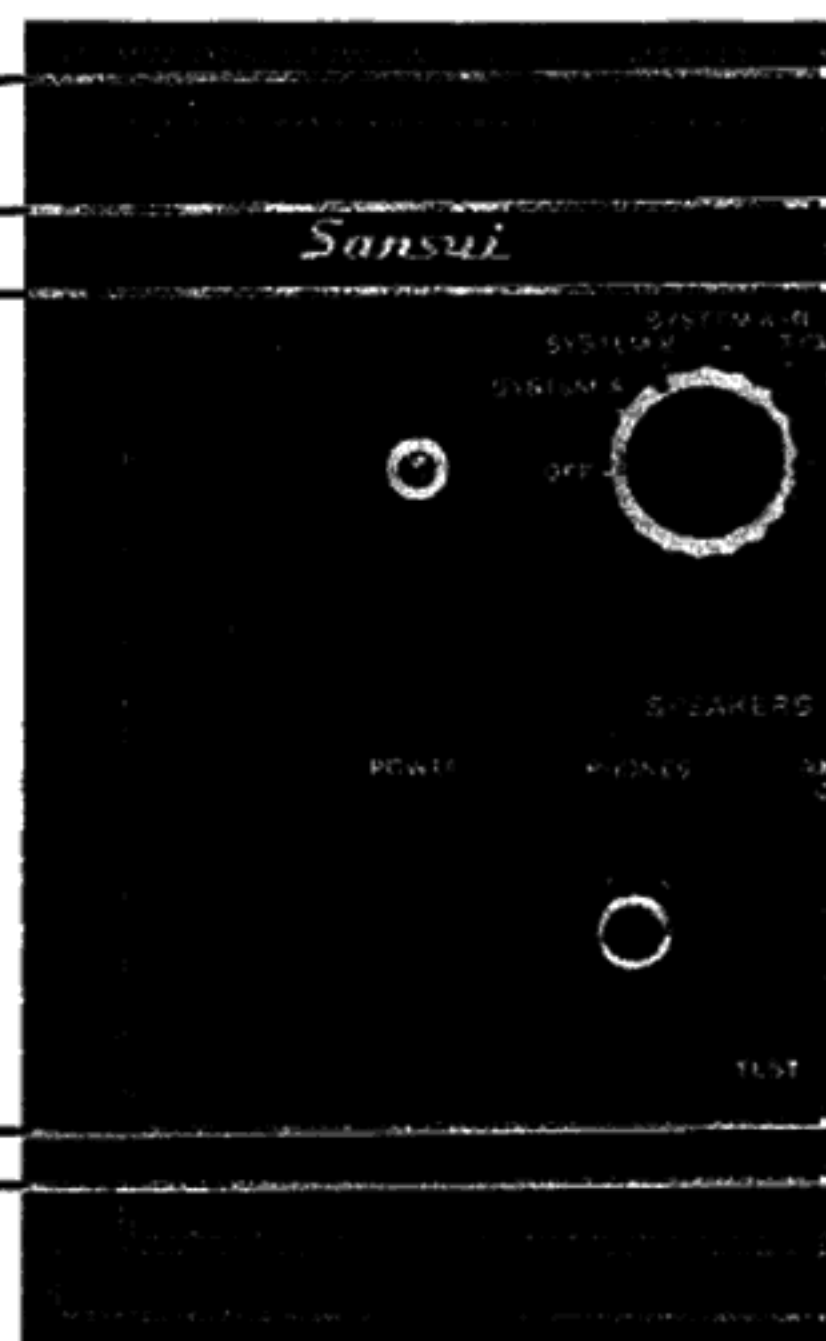

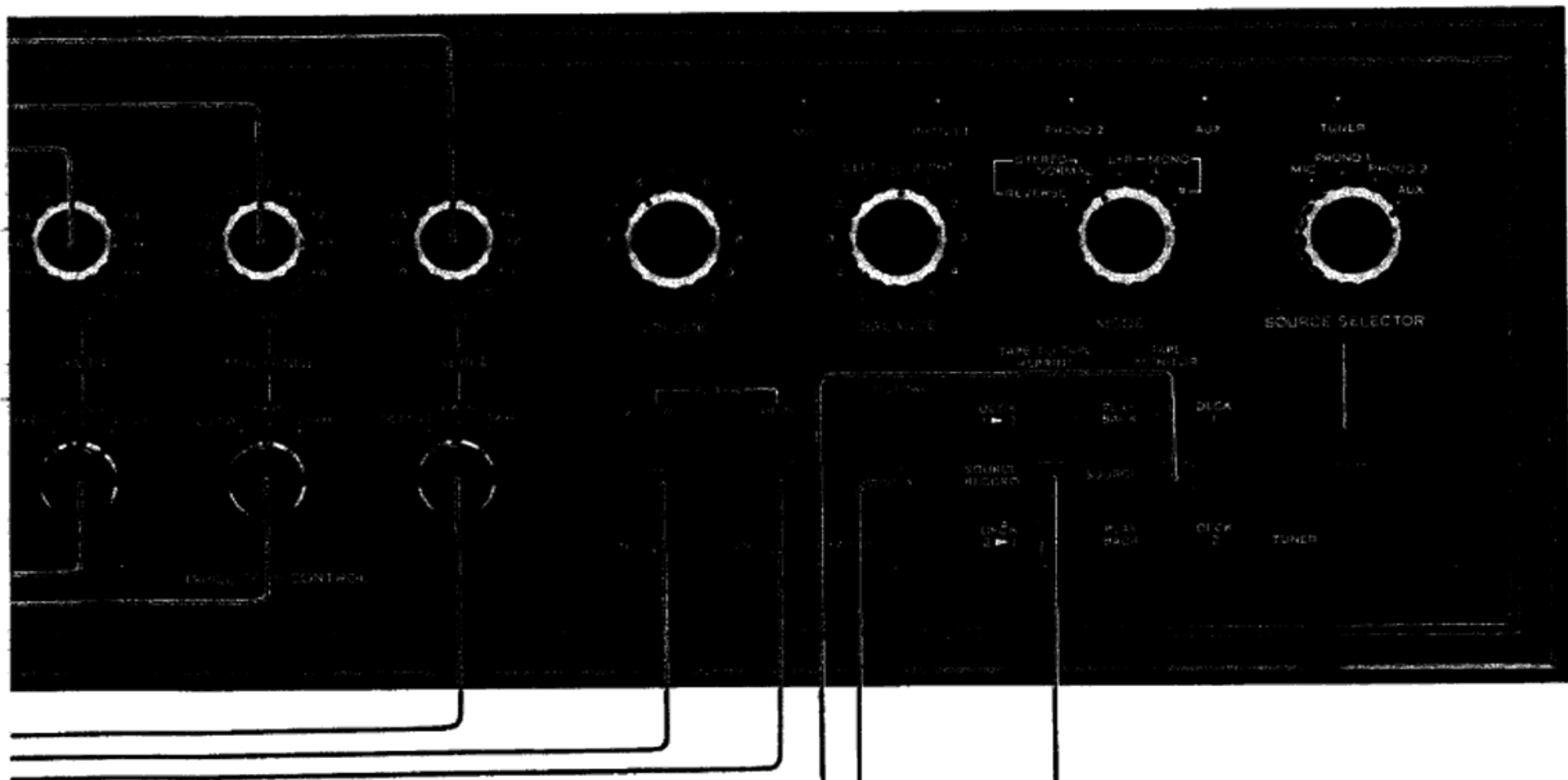

Tape Monitor Switch

Two stereo tape decks can be connected to the amplifier. When using 3-head tape decks, this switch allows recording directly from any program set up on the amplifier, and at the same time allows listening to the actual recording as picked up by the playback head.

DECK 1: Selects the tape deck connected to the TAPE 1 or TAPE RECORDER jacks.

DECK 2: Selects the tape deck connected to the TAPE 2 jacks.

When not in use, make sure the switch is in the SOURCE position.

Muting Switch

The Muting switch attenuates music and voice by 20 dB over the whole frequency range without use of the Volume control. This switch is used to suppress the background noise heard when changing a record, and to reduce the over-all sound level temporarily while playing a record.

Tape-to-Tape Reprint

When connecting two tape decks to the amplifier, this switch allows tape-to-tape recording.

DECK 1→2: Use this position for recording from tape deck 1 to tape deck 2.

SOURCE RECORD: With the switch in this position, any program source selected by the Source Selector switch can be recorded by either deck 1 or 2, or by both decks simultaneously.

DECK 2→1: Use this position for recording from tape deck 2 to tape deck 1.

Note: During the tape-to-tape reprinting process, monitoring is possible on either recording or playback side by setting the Tape Monitor switch to the DECK 1 or DECK 2 position. When the Tape Monitor switch is returned to the SOURCE position, it is possible to play a record as usual while reprinting.

OPERATIONS

— SPEAKER CONNECTIONS

— RECORD PLAYING

Connecting Loudspeakers

Three pairs of 4- to 16-ohm speakers can be connected to the amplifier. One set of speakers connected to the SYSTEM A terminals may be installed in your listening room and two other sets of speakers connected to the SYSTEM B and C outputs may be installed in other rooms of your home. The Speakers switch selects from among the A, B and C speakers. When it is set to the SYSTEM A+B position, you will hear sound from both speaker systems. Only the C speakers can be used as a component of the Electronic Crossover System. A detailed description will be found in the section entitled **Electronic Crossover System**.

To connect the main set of speakers to the amplifier:

1. Connect the positive terminal of the speaker on your right (as viewed from the listening area) to the right channel SYSTEM A (+) terminal on the rear of the amplifier.
2. Connect the lead from the negative speaker terminal (marked -) to the right channel SYSTEM A (-) terminal on the rear of the amplifier.
3. The left speaker connections are made at the left channel SYSTEM A terminals on the rear of the amplifier in the manner described above.
4. Set the SPEAKERS selector to SYSTEM A.

In connecting speakers to the amplifier, no more than $\frac{1}{4}$ -inch of insulation should be removed from the end of a speaker cable, since any greater length of exposed wire is likely to cause shorts at the terminals. All wire strands should be tightly twisted. To connect, depress the terminal button with one hand, push the stripped end of lead wire in the hole with the other hand, and release the button.

If you wish to connect one or two more sets of speakers in the same room or remotely, you can connect such speakers to the SYSTEM B and C terminals of each channel as indicated above. To listen to sound from the B or C speakers, be sure to turn the Speakers switch to the SYSTEM B or C position respectively.

RECORD PLAYERS

Connecting Record Players

The AU-999 has two sets of PHONO inputs to accommodate a pair of players. The PHONO 1 has the input impedance of 50 k Ω . The PHONO 2 can be switched between 30, 50 and 100 k Ω by means of the PICKUP LOAD switch on the rear panel.

To connect a record player to the amplifier, proceed as follows:

1. Connect the left channel output of the record player to the LEFT PHONO 1 (or PHONO 2) input jack on the rear of the amplifier.
2. Connect the right channel output of the record player to the RIGHT PHONO 1 (or PHONO 2) input jack.
3. If a monophonic player or turntable is used, it may be connected to either LEFT or RIGHT PHONO input jack.

Listening to a Stereo or Mono Record

1. Set the SOURCE SELECTOR switch to PHONO 1 or PHONO 2 depending on which input is being used. Check the TUNER SELECTOR switch to see if it is in its up position.
2. Set the MODE switch to STEREO. If a monophonic record player is used, set the MODE switch to MONO.
3. Make appropriate settings of controls on the record player.
4. Place the needle on the record.
5. Adjust the BALANCE control for equal sound from both right and left speakers.
6. Use all other controls and switches according to your personal taste and room acoustics.

Note: When monophonic records are played on a stereo player, follow the same procedures as for stereophonic records for better results.

Insert the power-cord plug of the player into one of the two A.C. outlets marked SWITCHED on the rear of the amplifier. The power supply will then be controlled by the front POWER switch.

== LEFT CHANNEL
 — RIGHT CHANNEL

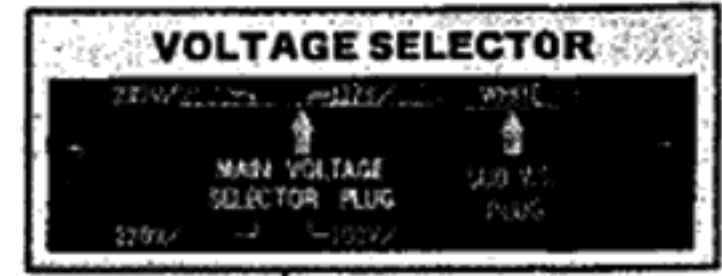

PM CONNECTOR

CONNECTING TO SPEAKER TERMINALS



TO RECORD PLAYER

PICKUP LOAD SWITCH

RECORD PLAYER

RECORD PLAYER

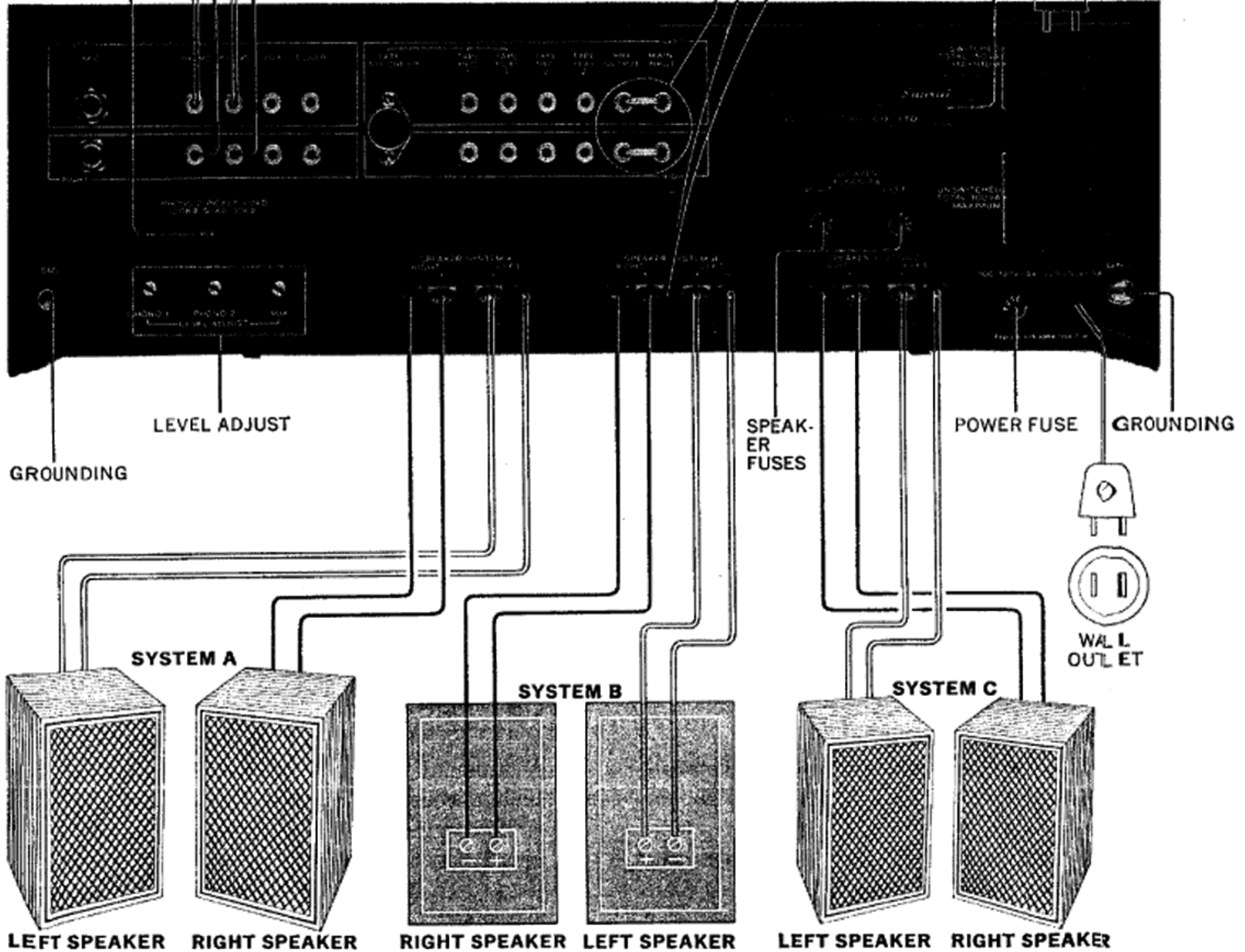

OPERATIONS

— RADIO RECEPTION

— MICROPHONES

TUNERS

Connecting Tuners

For a stereo tuner, connect its left channel output to the left channel TUNER input jack, and its right channel output to the right channel TUNER input jack. For a monophonic tuner, connect its output to either left or right jack. For use with an FM-MPX adaptor, connect the tuner output to the adaptor input; then connect the left channel output of the adaptor to the left channel TUNER jack, and the right channel output of the adaptor to the right channel TUNER jack.

Listening to a Stereo FM Program

1. Set the TUNER SELECTOR switch to its down or TUNER position.
2. Set the MODE switch to STEREO.
3. Use tuning controls to reach the desired station. Make appropriate settings of controls on the tuner.
4. Adjust the amplifier's front panel controls and switches according to your personal taste and room acoustics.

Listening to a Mono Program

1. Set the TUNER SELECTOR switch to its down or TUNER position.
2. Set the MODE switch to MONO.
3. Use tuning controls to reach the desired station. Make appropriate settings of controls on the tuner.
4. Adjust the amplifier's front panel controls and switches according to your personal taste and room acoustics.

For Use with an FM-MPX Adaptor

1. Set the TUNER SELECTOR switch to its down or TUNER position.
2. Set the MODE switch to STEREO.
3. Use tuning controls to reach the desired station.
4. Make appropriate settings of controls on the FM-MPX adaptor.
5. Adjust the amplifier's front panel controls and switches according to your personal taste and room acoustics.

MICROPHONES

One or two microphones can be connected to the MIC inputs on the rear of the amplifier. Use high-impedance 50-k Ω dynamic or velocity microphones for optimum performance.

Connections

If two microphones are used, connect one to the RIGHT MIC input and the other to the LEFT. If only one microphone is used, connect it to either RIGHT or LEFT MIC input.

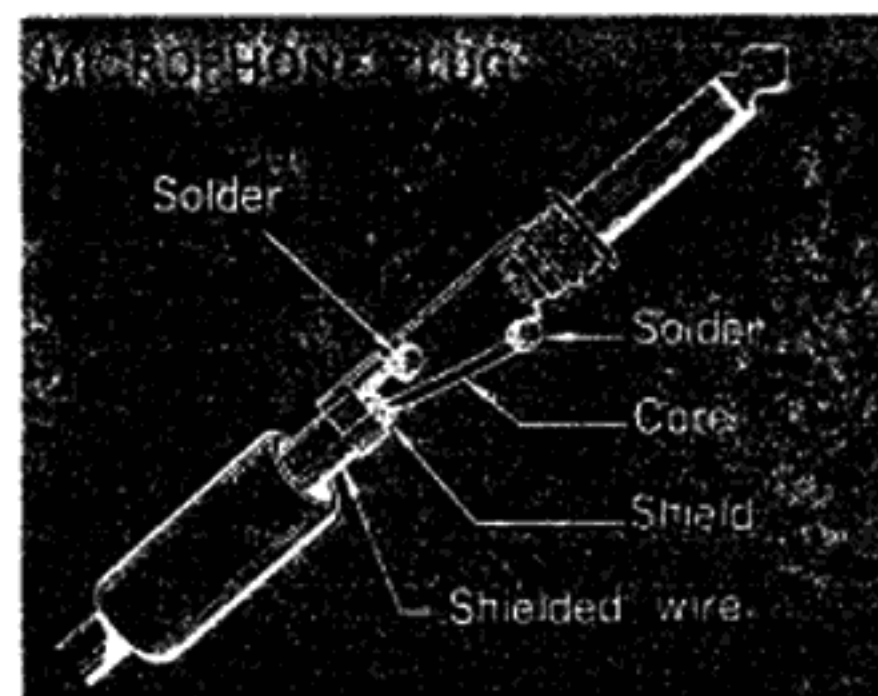

Operation

1. Turn the SOURCE SELECTOR switch to MIC. Check the TUNER SELECTOR switch to see if it is in its up position.
2. If two microphones are used, set the MODE switch to MONO L+R for mixing the two input signals or to STEREO for separate use of the two microphones. If only one microphone is used, set the MODE switch to MONO L or MONO R depending on which input is being used.
3. Use all other controls and switches according to taste and listening conditions.

CAUTION: When you connect one set of speakers to the SYSTEM A terminals and another set of speakers to the SYSTEM B in order to use them simultaneously with the Speakers switch set in its SYSTEM A+B position, each speaker must have impedance of 8 ohms or more. If a 4 ohm impedance speaker is used, the amplifier may be damaged.

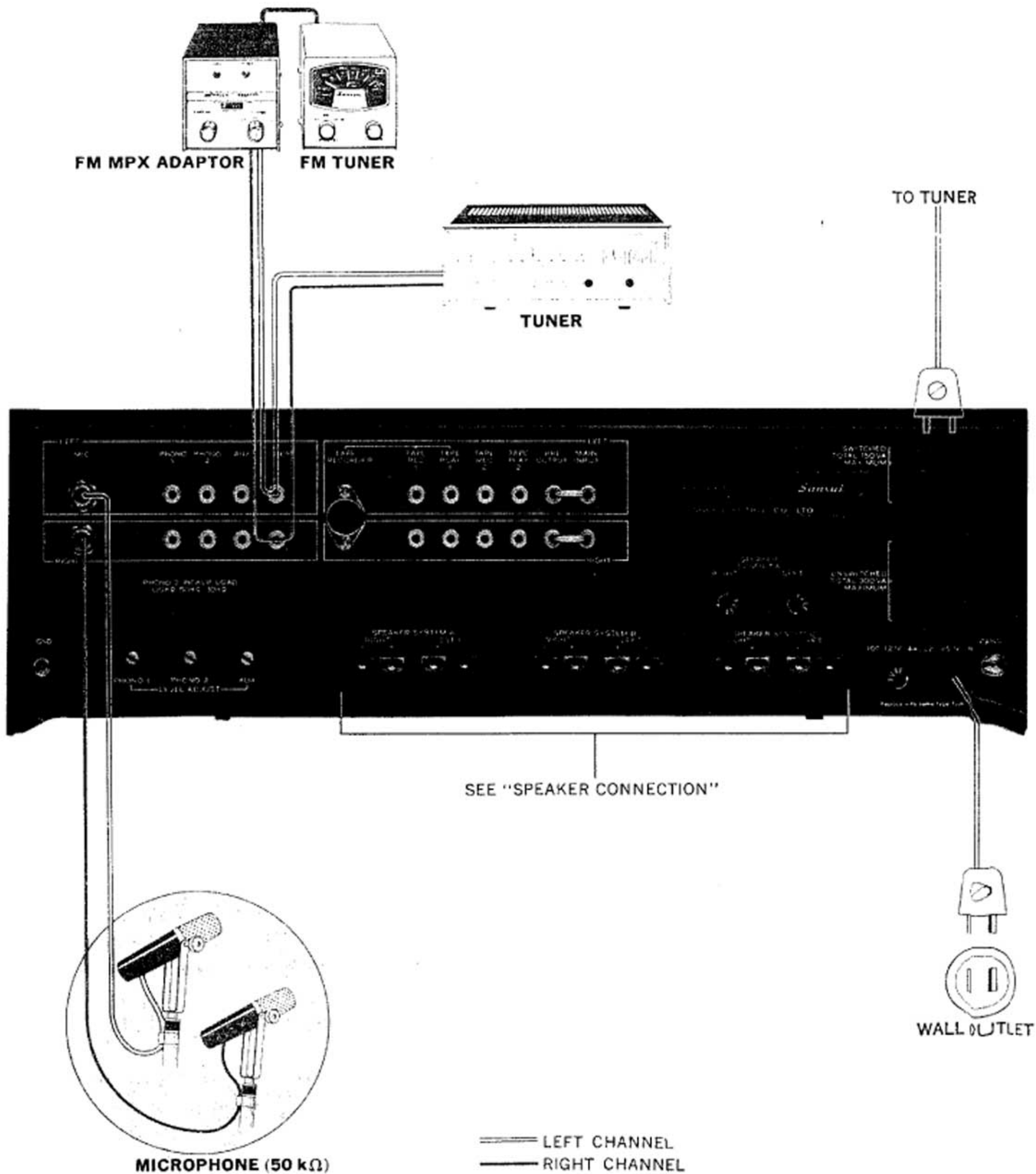

OPERATIONS

— TAPE PLAYBACK — TAPE RECORDING

TAPE DECKS

Connecting Tape Decks

Tape decks can be connected to record from, and playback through, the AU-999. Tape monitoring is possible with a tape machine having a built-in pre-amplifier as well as separate recording and playback heads.

Tape Deck with DIN Connector

If your tape deck has a DIN (German Industrial Standard) 5-pin plug, plug it into the TAPE RECORDER socket on the rear panel of the amplifier. **Caution:** The tape deck having a DIN connector must not be used together with another tape deck connected to the TAPE 1 jacks. To use both decks simultaneously, the latter tape deck should be connected to the TAPE 2 jacks.

Pin-Jack Tape Deck

To record on tapes from the amplifier:

1. Connect the left channel input of the tape deck to the left channel TAPE 1 (or 2) REC jack on the rear of the amplifier.
2. Connect the right channel input of the tape deck to the right channel TAPE 1 (or 2) REC jack.
3. If a monophonic tape recorder is used, it may be connected to either left or right TAPE REC jack.

To playback through the amplifier:

1. Connect the left channel output of the tape deck to the left channel TAPE 1 (or 2) PLAY jack on the rear of the amplifier.
2. Connect the right channel output of the tape deck to the right channel TAPE 1 (or 2) PLAY jack.
3. If a monophonic tape recorder is used, it may be connected to either left or right TAPE PLAY jack.

Recording on Tapes

1. Set the SOURCE SELECTOR switch to the program to be recorded.
2. Set the MODE switch to STEREO. If a monophonic tape recorder is used, set the switch to

MONO.

3. Make appropriate settings of controls on the tape deck.

To record on a pair of tapes simultaneously by using two tape decks connected to the TAPE 1 and 2 jacks:

1. Set the SOURCE SELECTOR switch to the program to be recorded.
2. Set the TAPE-TO-TAPE REPRINT switch to SOURCE RECORD.
3. Set the tape decks in the recording mode.
4. Use other controls and switches appropriately.

Listening to Tapes

1. Turn the TAPE MONITOR switch to PLAYBACK DECK 1 or 2.
2. Set the MODE switch to STEREO. If a monophonic tape recorder is used, set the switch to MONO.
3. Make appropriate settings of controls on the tape deck.
4. Use the amplifier's front panel controls and switches according to your personal taste and listening conditions.

Tape Monitoring

Monitoring is possible only with a tape deck which has its own playback preamplifier as well as separate recording and playback heads. Set the TAPE MONITOR switch to PLAYBACK and use all other controls and switches according to your personal taste and listening conditions.

Tape-to-Tape Reprinting

To record from the tape deck connected to the TAPE 1 jacks to the tape deck connected to the TAPE 2 jacks:

1. Turn the TAPE-TO-TAPE REPRINT switch to DECK 1 → 2.
2. Set tape deck 2 in the recording mode.
3. Set tape deck 1 in the playback mode.
4. Use other controls and switches appropriately.

To record from tape deck 2 to tape deck 1:

1. Turn the TAPE-TO-TAPE REPRINT switch to DECK 2 → 1.
2. Set tape deck 1 in the recording mode.
3. Set tape deck 2 in the playback mode.
4. Use other controls and switches appropriately.

Notes:

1. Tape recorded sound cannot be controlled by the controls and switches on the front panel of the amplifier. They control sound from the speakers only.
2. For better results, record directly through the

AU-999, rather than through microphones placed in front of the speakers.

3. Before connecting and operating the tape decks, be sure to look up the manufacturer's operating instructions.

4. The TAPE MONITOR switch should be in the SOURCE position except when the tapes are being monitored or played back by the tape deck. When the switch is in the PLAY BACK position, signals from any other source will not be heard from the speakers.

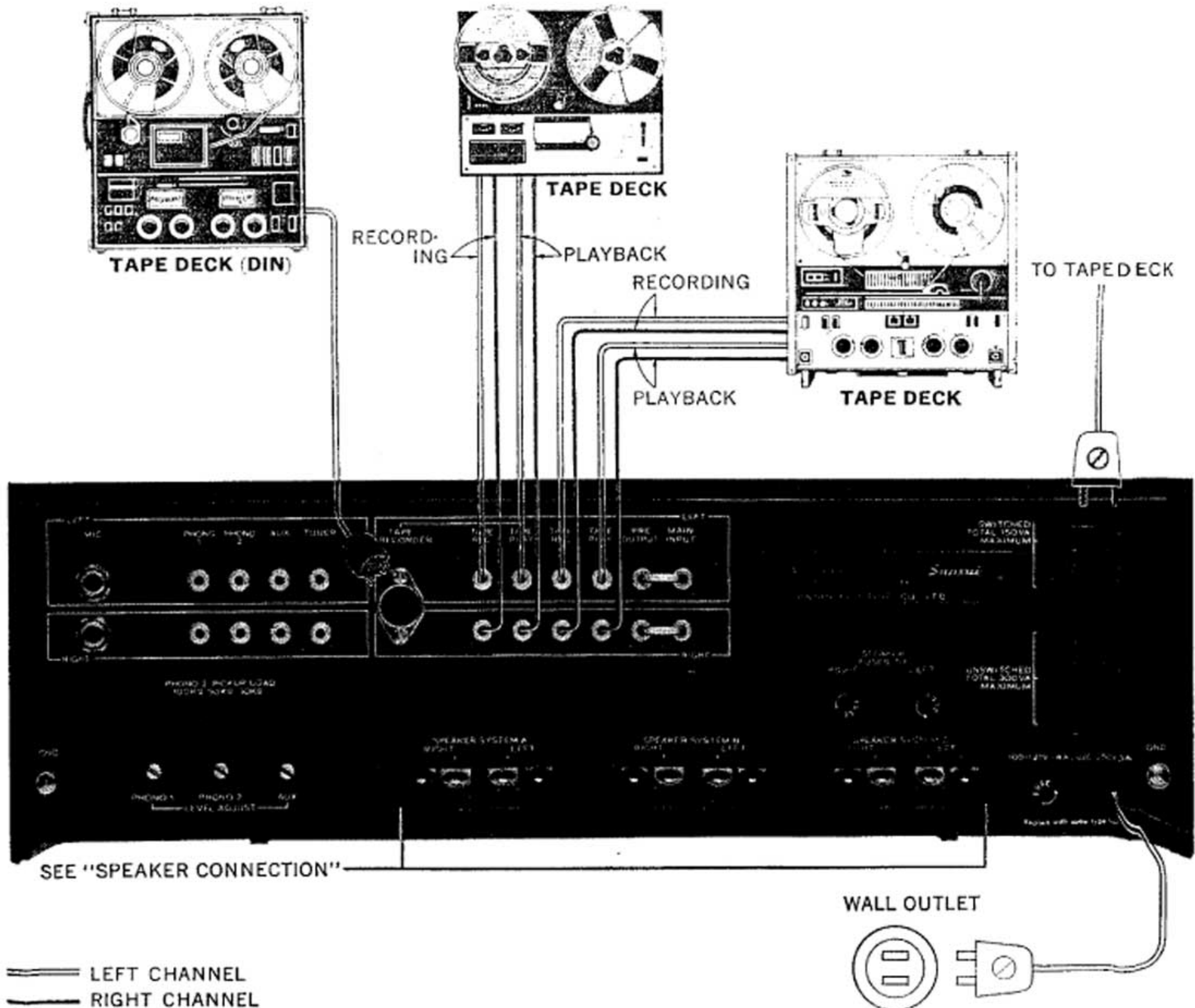

ELECTRONIC CROSSOVER SYSTEM

Electronic Crossover System

The electronic crossover system is said to be the best hi-fi sound reproduction method available, featuring the following advantages:

1. Since the tweeters, midranges and woofers have their own amplifier, any speakers of different impedance and efficiency can be used for stereo arrangement.
2. This system has better filter characteristics than the conventional LC crossover network. You can determine the optimum crossover points for the speakers used.
3. Since there is no component between the amplifier and speaker, the damping factor of the amplifier is not affected and it is directly coupled to the speaker.
4. This system allows use of the power amplifiers effectively and efficiently. For instance, a big-power amplifier can be used for woofers, and ones with good characteristics for midranges and tweeters. You can select the amplifiers suitable for each of the woofers, midranges and tweeters.

The AU-999's preamp and main amplifier sections can be used separately by simply removing a pair of connectors from the PRE OUTPUT and MAIN INPUT jacks on the rear panel. This feature enables you to use the AU-999 as a component of an Electronic Crossover System in the following manner:

1. Set the SPEAKERS switch to SYSTEM C.
2. Remove the two connectors from the PRE OUTPUT and MAIN INPUT jacks.
3. Connect an electronic crossover unit (Sansui CD-5) to the PRE OUTPUT jacks.
4. Connect the low-frequency output of the electronic crossover unit to the MAIN INPUT jacks on the AU-999.
5. Connect the right and left woofers to the SYSTEM C terminals on the AU-999.
6. Connect the mid-frequency output of the electronic crossover unit to the inputs of the second separate power amplifier (Sansui BA-90), and the right and left midrange speakers to the said power

amplifier.

7. Connect the high-frequency output of the electronic crossover unit to the inputs of the third separate power amplifier (Sansui BA-90), and the right and left tweeters to the said power amplifier.

Notes:

1. You can connect speakers to the SYSTEM A and B terminals in addition to the SYSTEM C and directly compare the sound of the Electronic Crossover System with that of the ordinary stereo arrangement by turning the SPEAKERS switch between the SYSTEM A, B and C positions.
2. The connection of an additional pre-amplifier to the MAIN INPUT jacks cuts off all front panel switches and controls except the BALANCE CHECK and SPEAKERS switches. Thus, to adjust the tone and volume, operate the controls of the additional pre-amplifier connected to the AU-999. When an additional power amplifier is connected to the PRE OUTPUT jacks, the tone and volume can be adjusted by the controls of the AU-999.

ELECTRONIC CROSSOVER SYSTEM

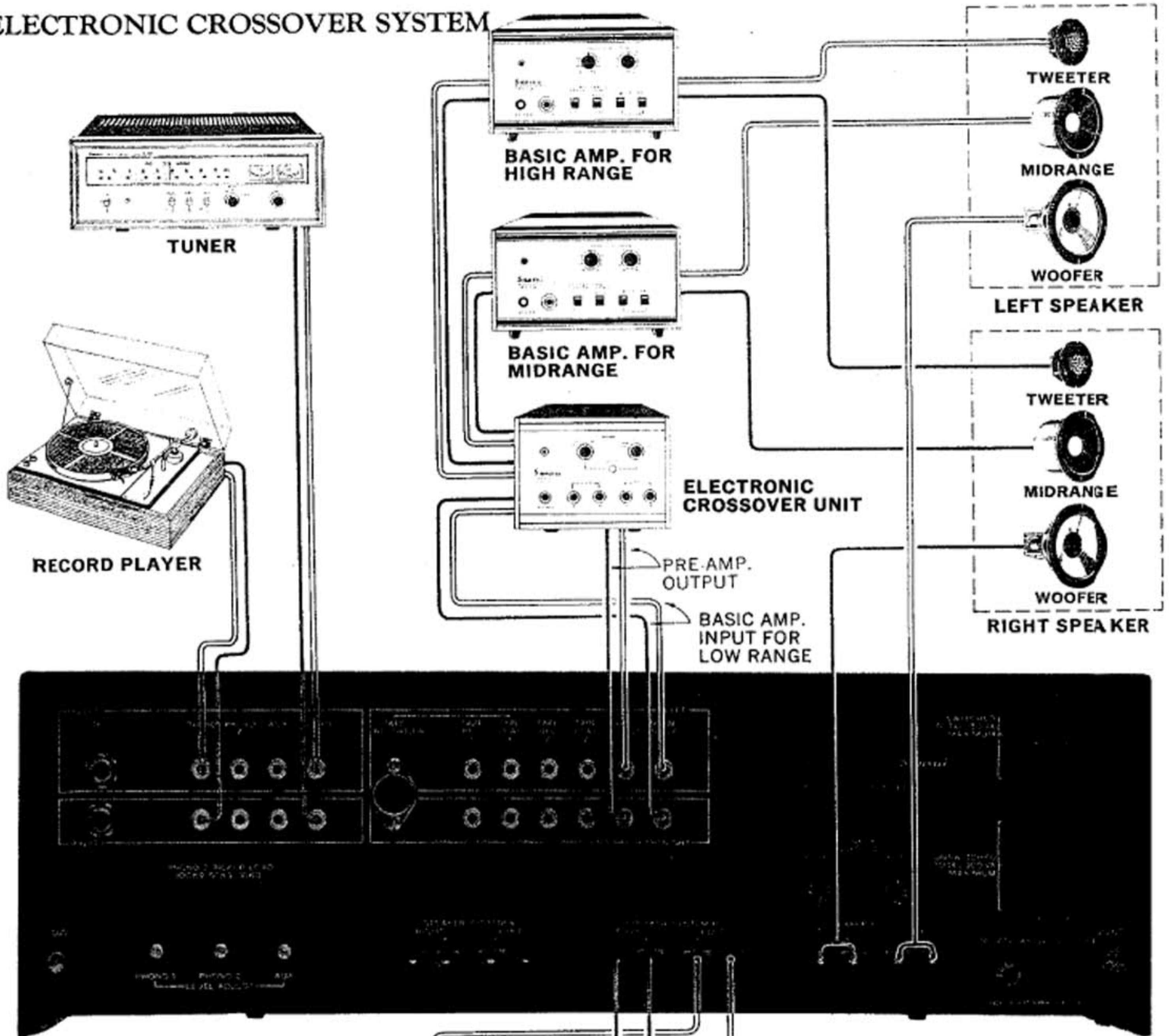

STANDARD STEREO SYSTEM

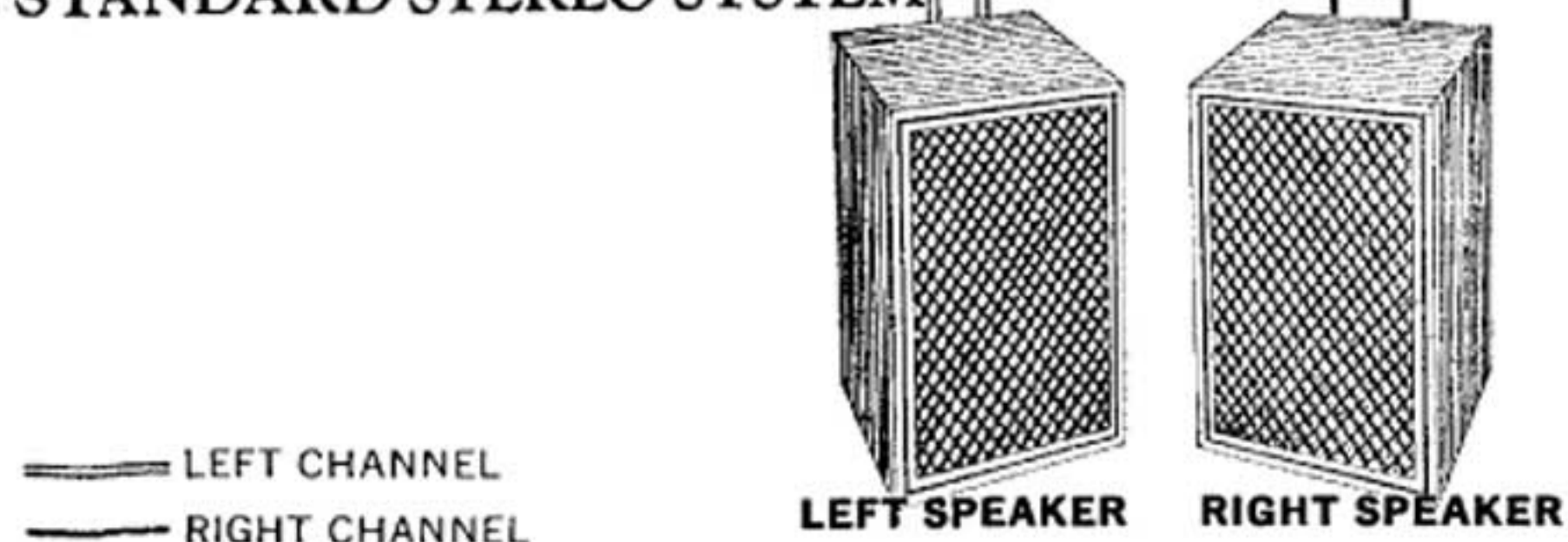

MAINTENANCE

PM Connectors

Warning: Be sure to turn the POWER switch OFF before removing the PM connectors.

The PM connectors hook up the PRE OUTPUT and MAIN INPUT terminals on the rear panel of the amplifier. When the PM connectors are removed with the SPEAKERS switch set in the SYSTEM C position, the pre-and main amplifier sections can be used individually and separately. They should not be removed except when connecting additional pre- and/or main amplifiers. Refer to the section entitled Electronic Crossover System.

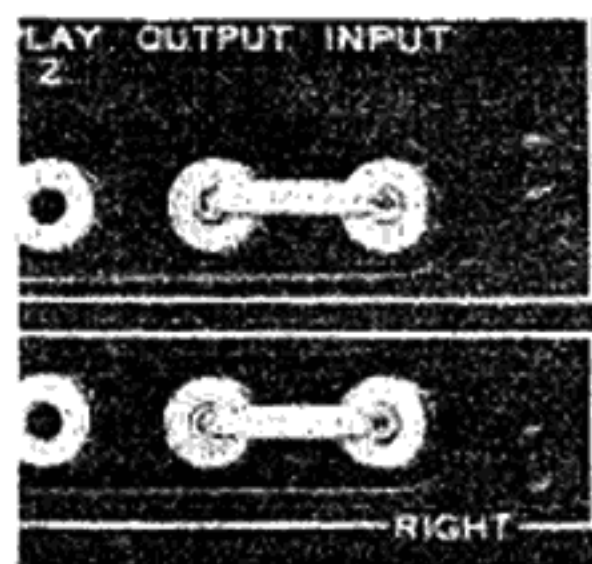

Level Adjustments

AUX: This level control determines the strength of signals fed into the AUX inputs.

PHONO 1 and 2: Two level controls are provided to adjust the loudness of each phonograph input. Adjust these controls so that there will not be any difference in the loudness level between the PHONO 1 and 2 inputs.

To increase the loudness level, turn the controls clockwise with a screwdriver; to decrease, turn them counterclockwise.



Connecting Wire

Be sure to use adequately thick shieldwire when connecting tape decks, record players or other components to the AU-999. The use of an ordinary twin leadwire may cause hum or noise. Don't use shieldwire longer than 7 feet (2 meters). The use of a longer wire leads to greater attenuation at high frequencies.

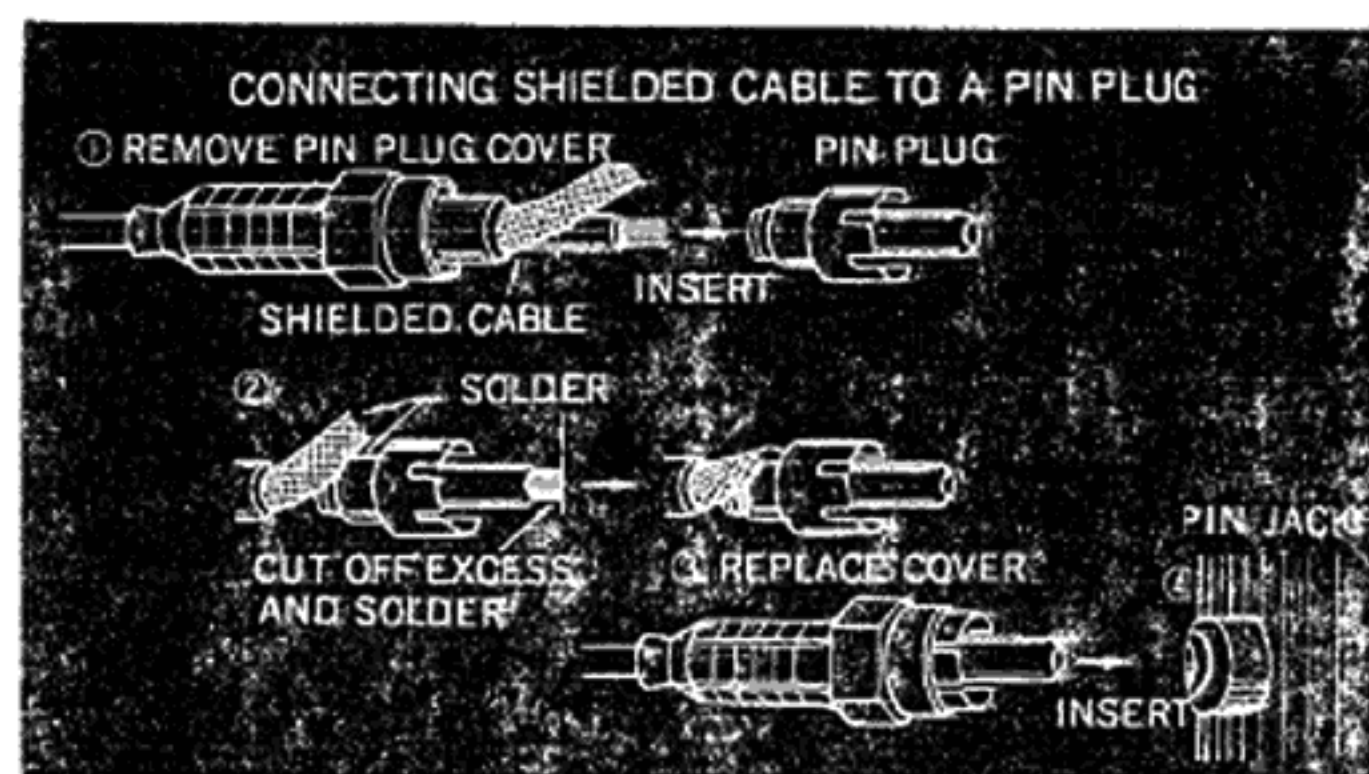

Connections

Always check to see that leads are connected firmly and properly to their corresponding output or input terminals. If the connections are loose or in touch with other parts, the AU-999 will not perform normally, and may produce undesirable noise. If used in such a way for a long time, it will eventually break down. Always read the manufacturer's instructions for tape decks, record players, etc. before connecting.

Where to Place

Since transistors are extremely susceptible to heat, the AU-999 has been designed to diffuse heat through the top and rear of its case. Therefore, special consideration should be given to where it will be used before installing the system. It should not be operated in a place where it is exposed directly to the sun, near radiators or other heat-generating sources, and it should never be mounted in an air-tight cabinet. Finally, nothing should be placed on top of it.

Hum and Howling

If, when using a tape deck or record player, unpleasant humming or howling is heard, it is usually a result of the following.

The record player is placed on or near the speaker box causing sound waves to be transmitted from the speaker to the player (howling). To prevent this, place the record player away from the speaker box or put a thick cushion between the two components.

A low buzzing sound will also be produced if adequately thick shieldwire is not used for connections, or if connections have not been properly made. Be sure that the shieldwire is properly soldered to the pin-plugs as illustrated in "Connecting Wire", and that the motor and pickup arm or the record player are properly grounded.

Speaker Impedance

Combined impedance of speakers in each channel should not be less than 4 ohms. Too low impedance may blow quick-acting fuses or may cause damage to the amplifier after use over a long period.

Phasing of Speakers

Stand about 10 feet in front of and midway between the speakers and listen to any monophonic reproduction. If the speakers are correctly phased, the sound will seem to come from between the speakers. If the sound is not directly in front of you, the speakers are incorrectly phased. To correct this switch the amplifier off and reverse the leads to one speaker.

Care should be taken not to connect a single speaker system between the SYSTEM A and B terminals.



Grounding

Connect one end of vinyl or enameled wire to the terminal screw marked GND on the rear of the amplifier, attach a copper plate to the other end and bury it underground. Whenever an outdoor AM antenna is used, grounding becomes necessary. In all cases, grounding is desirable since it allows a better SN ratio to be obtained. To ground an entire audio system, connect the grounding wire of each component used to this terminal.

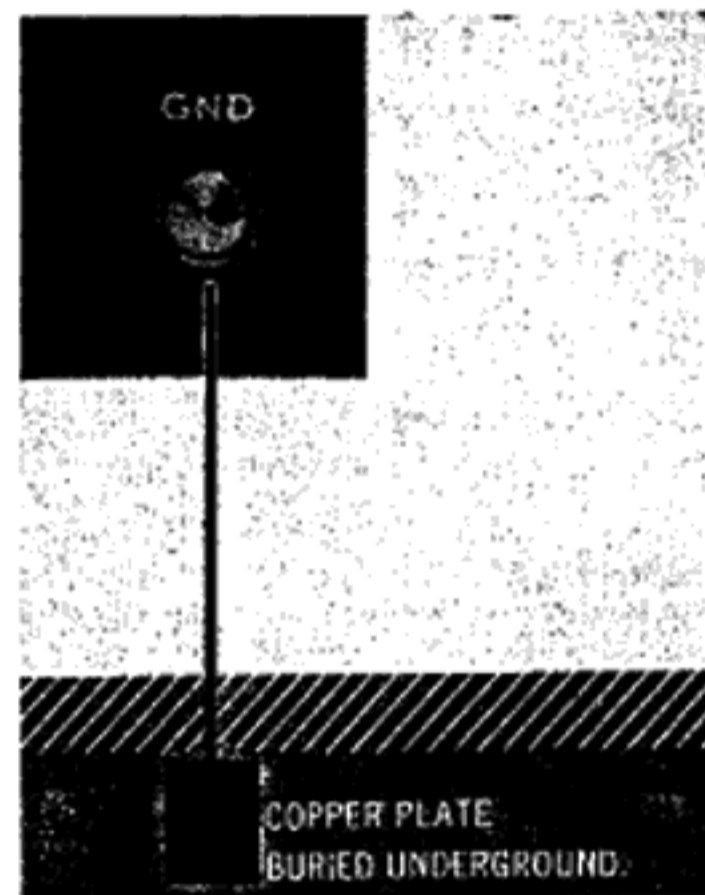

Quick-Acting Fuses

The AU-999 is double protected by the quick-acting fuses at every power transistor stage and in the power circuit. If sound from the speakers is distorted or not heard at all, immediately remove the power plug from its outlet; check for the blown **SPEAKER FUSES** on the rear panel; and, if necessary, replace them with the new 5-ampere fuses (supplied). If OK, remove the bonnet from the AU-999; check the inside fuses; and, if necessary, replace them with the new 5-ampere fuses (supplied). Before replacing, check for the source of trouble that caused the fuses to blow. If the new fuses blow as soon as the **POWER** switch is turned on, check for the defective power circuit. If the trouble source cannot be located, contact the nearest Sansui dealer or Service Center.

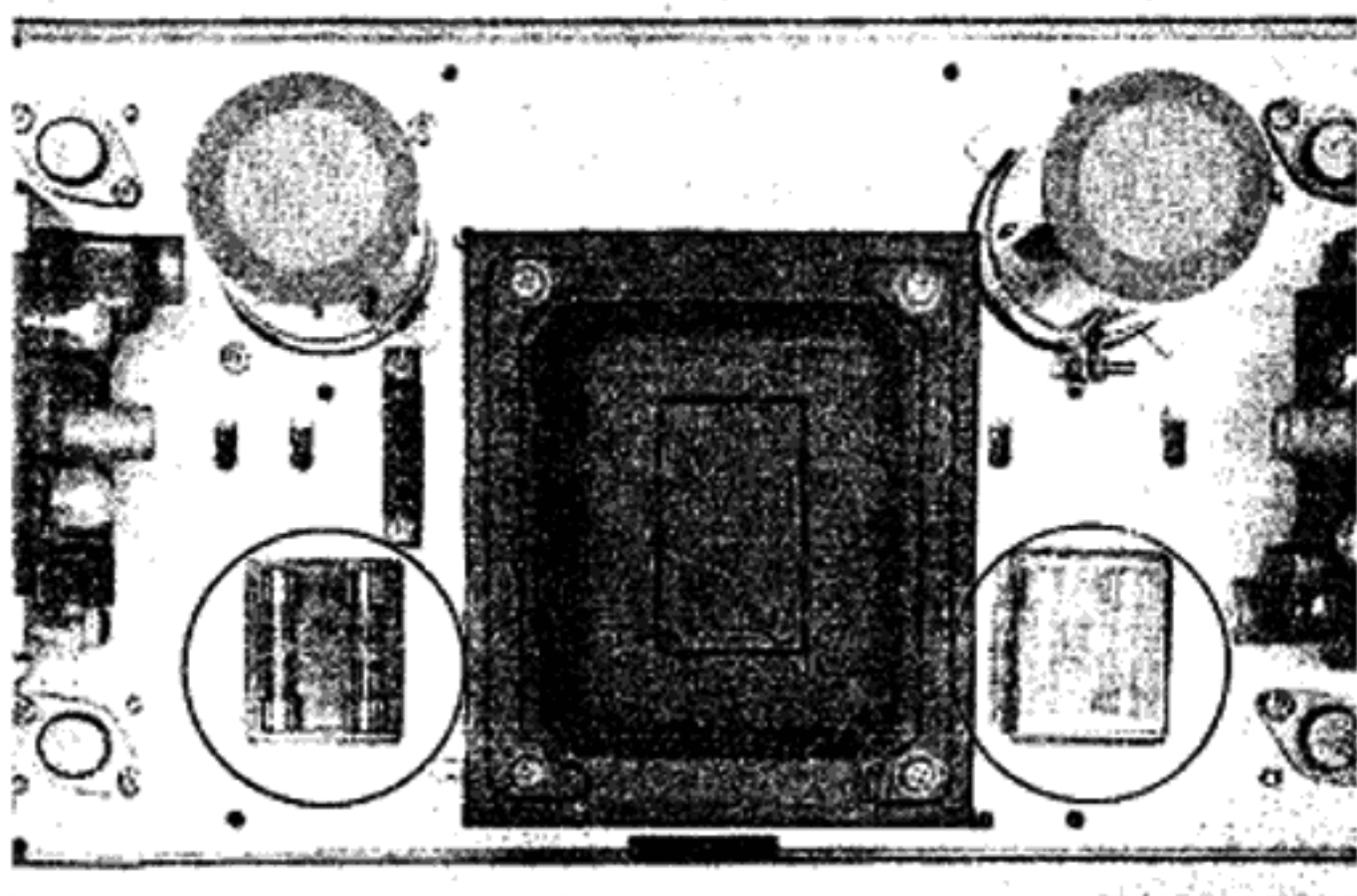
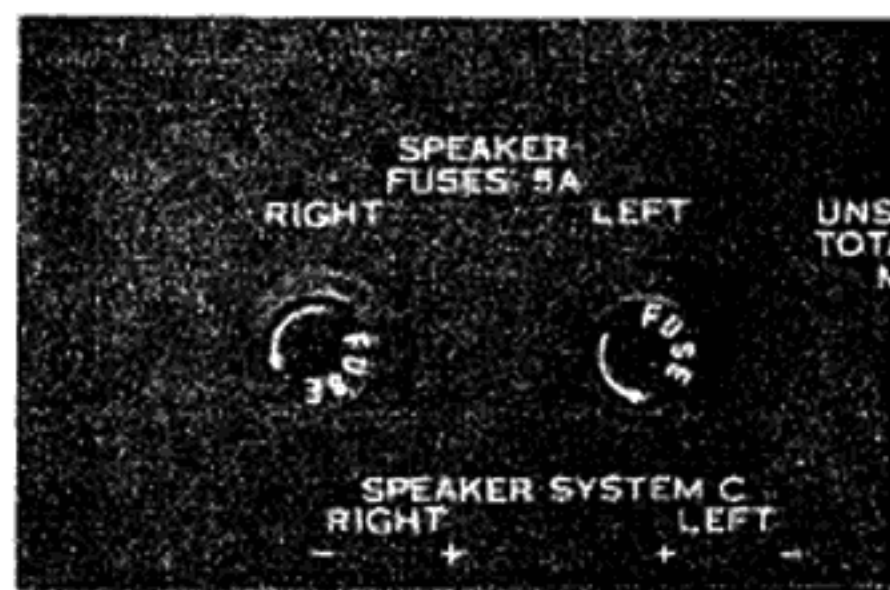

A.C. Outlets

The AU-999 is provided with five A.C. outlets on its rear panel. The upper two outlets marked

SWITCHED are switched on and off by the **POWER** switch on the front panel.

Caution: The upper two outlets have a maximum capacity of 150 VA total and the three other outlets 300 VA total. Never use them beyond their rated capacities.

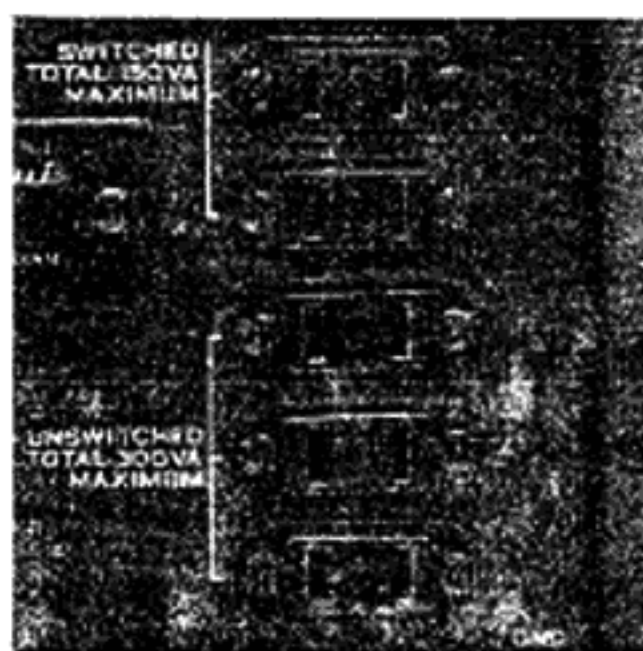

Power Fuse

CAUTION: For the power supply voltage of 100 to 127 volts, use a 4-ampere fuse; for 220 to 250 volts, use a 3-ampere fuse.

If the unit remains completely dead when the power is switched on (**POWER** indicator fails to light), the power fuse is probably blown. In this case, remove the power plug from its AC outlet and replace the fuse after finding and eliminating the trouble that caused the fuse to blow. (Consult the Troubleshooting Section in your Service Manual)

Use only a glass-tubed 4 (or 3)-ampere fuse. Never attempt to use a piece of wire or a fuse of a different capacity as a substitute.



Voltage Adjustment

To reach the voltage selector, remove the two screws from the nameplate on the rear panel and then remove the nameplate. The voltage selector makes it possible to operate the AU-999 at the correct voltage in any area. The voltage has been pre-adjusted at the factory, but can be easily re-adjusted as follows:

STEP I Set arrow of main voltage selector plug to required voltage: 100, 110, 117, 127, 220, 230, 240 or 250 volts.

STEP II If numerals of voltage are printed in red, set arrow of adjacent sub V.S. plug to position marked red. If there are printed in white, set arrow to position marked white.

Note: The Voltage Adjustor can be also used to eliminate trouble caused by considerable voltage fluctuation. In this case, it should be set to the peak voltage.



117V

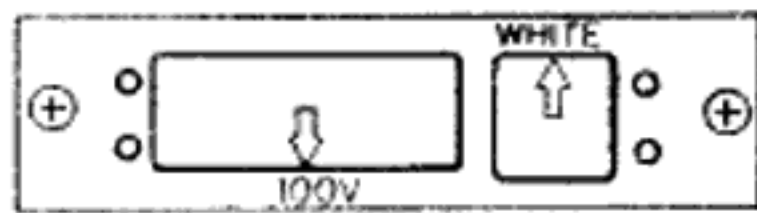

100V

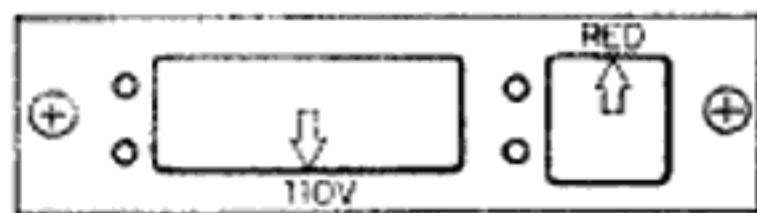

110V

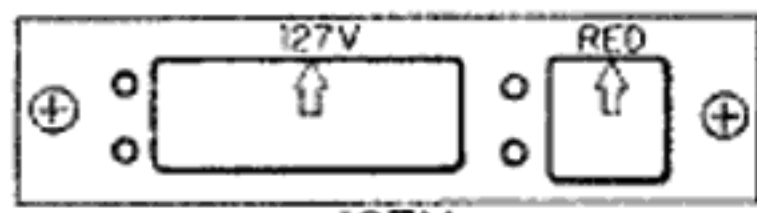

127V

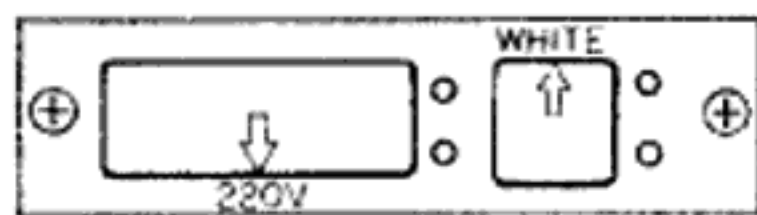

220V

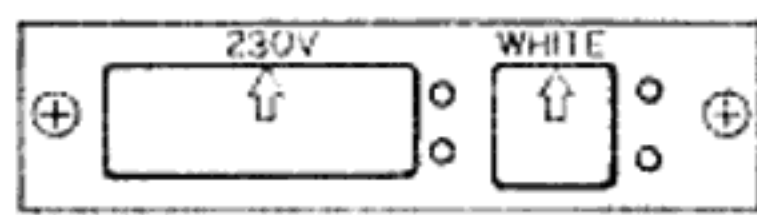

230V

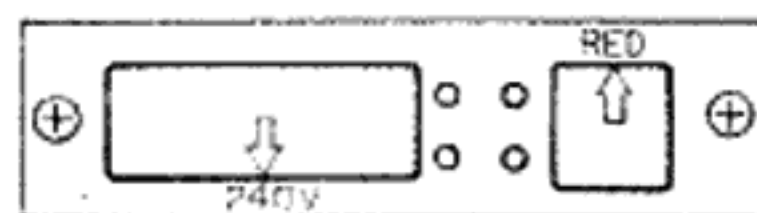

240V

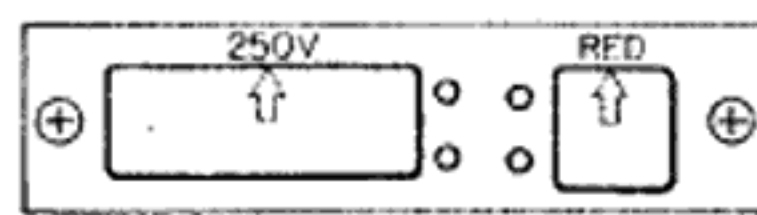

250V

Accessories List

1. OPERATING INSTRUCTIONS AND SERVICE MANUAL 1
2. OPERATING SHEET..... 1
3. PIN-PLUGS 4
4. MIC-PLUG..... 2
5. QUICK ACTING FUSES (SPEAKER FUSES) 5A..... 2
6. POLISHING CLOTH..... 1
7. BUTTERFLY BOLTS..... 2
8. WASHERS..... 2

SPECIFICATIONS

POWER AMPLIFIER SECTION:

POWER OUTPUT:

MUSIC POWER (IHF): 180W at 4 ohms load
140W at 8 ohms load

CONTINUOUS POWER: 70/70W at 4 ohms load
50/50W at 8 ohms load

TOTAL HARMONIC DISTORTION:

less than 0.4% at rated output

INTERMODULATION DISTORTION

(60Hz: 7,000Hz=4:1 SMPTE method)
less than 0.4% at rated output

POWER BANDWIDTH (IHF)

10 to 30,000Hz at 8 ohms load

FREQUENCY RESPONSE (at normal listening level):

5 to 100,000Hz \pm 1dB

CHANNEL SEPARATION (at 1,000Hz, rated output):
better than 50dB

HUM AND NOISE (IHF) better than 100dB

INPUT SENSITIVITY: 1V for rated output

INPUT IMPEDANCE: 50k ohms

LOAD IMPEDANCE: 4 to 16 ohms

DAMPING FACTOR: 45 at 8 ohms load

PRE-AMPLIFIER SECTION

OUTPUT VOLTAGE:

MAXIMUM OUTPUT VOLTAGE: 5V

RATED OUTPUT VOLTAGE: 1V

TOTAL HARMONIC DISTORTION:

less than 0.1% at rated output voltage

FREQUENCY RESPONSE:

20 to 70,000Hz \pm 0.5dB - 1.5dB

HUM AND NOISE (IHF):

PHONO-1 and 2: better than 80dB

MIC: better than 80dB

TUNER and AUX: better than 85dB

INPUT SENSITIVITY

(at 1,000Hz, rated output voltage)

PHONO-1 2mV (50k ohms)

PHONO-2 2mV (30k, 50k, 100k ohms)

MIC: 3mV (50k ohms)

TUNER: 200mV (50k ohms)

AUX: 200mV (50k ohms)

TAPE MON (pin): 200mV (50k ohms)

TAPE RECORDER (DIN):

200mV (50k ohms)

RECORDING OUTPUT:

TAPE REC (pin): 200mV

TAPE RECORDER (DIN): 30mV

EQUALIZER:

PHONO, MIC: NF type

CONTROLS:

BASS: +12dB - 8dB at 20Hz

MIDRANGE: +5dB - 5dB at 1,000Hz or
2,000Hz

TREBLE: +12dB - 8dB at 20,000Hz

TONE SELECTOR:

BASS: DEFEAT, 200Hz, 400Hz

MIDRANGE: DEFEAT, 1,000Hz, 2,000Hz

TREBLE: DEFEAT, 6,000Hz, 3,000Hz

SWITCHES:

LOW FILTER: -20dB at 20Hz
(12dB/oct, NF type)

HIGH FILTER: -18dB at 20,000Hz
(12dB/oct, NF type)

MUTING: -20dB

MODE: STEREO-REV, STEREO-NORM,
MONO-L+R, MONO-L, MONO-R

SOURCE SELECTOR: MIC, PHONO-1, PHONO-2, AUX

TUNER SELECTOR: OFF, ON

TAPE MONITOR: PLAYBACK DECK-1, SOURCE,
PLAYBACK DECK-2

TAPE TO TAPE REPRINT:

DECK-1 to 2 SOURCE RECORD,
DECK-2 to 1

SPEAKER SELECTOR: OFF, SYSTEM-A, SYSTEM-B,
SYSTEM-A+B, SYSTEM-C
(PRE- and MAIN SEPARATED)

BALANCE CHECK: NORMAL, TEST

THE OTHER ACCESSORIES:

5-pin DIN socket for Tape Recorder, Head Phone Jack,
Input Level Adjuster for PHONO-1, PHONO-2 and AUX,
One-touch clip type Speaker Terminals
Source Selector Indicator

TRANSISTORS AND DIODES:

Transistors; 41 Diodes; 16 Triac; 2

POWER REQUIREMENTS:

POWER VOLTAGE: 100, 110, 117, 127, 220, 230,
240, 250V 50/60Hz

POWER CONSUMPTION:

370W (max. signal)

DIMENSIONS:

18 $\frac{1}{8}$ "W \times 6 $\frac{1}{8}$ "H \times 12 $\frac{1}{2}$ "D

WEIGHT:

38.5 lbs.

CHARACTERISTICS

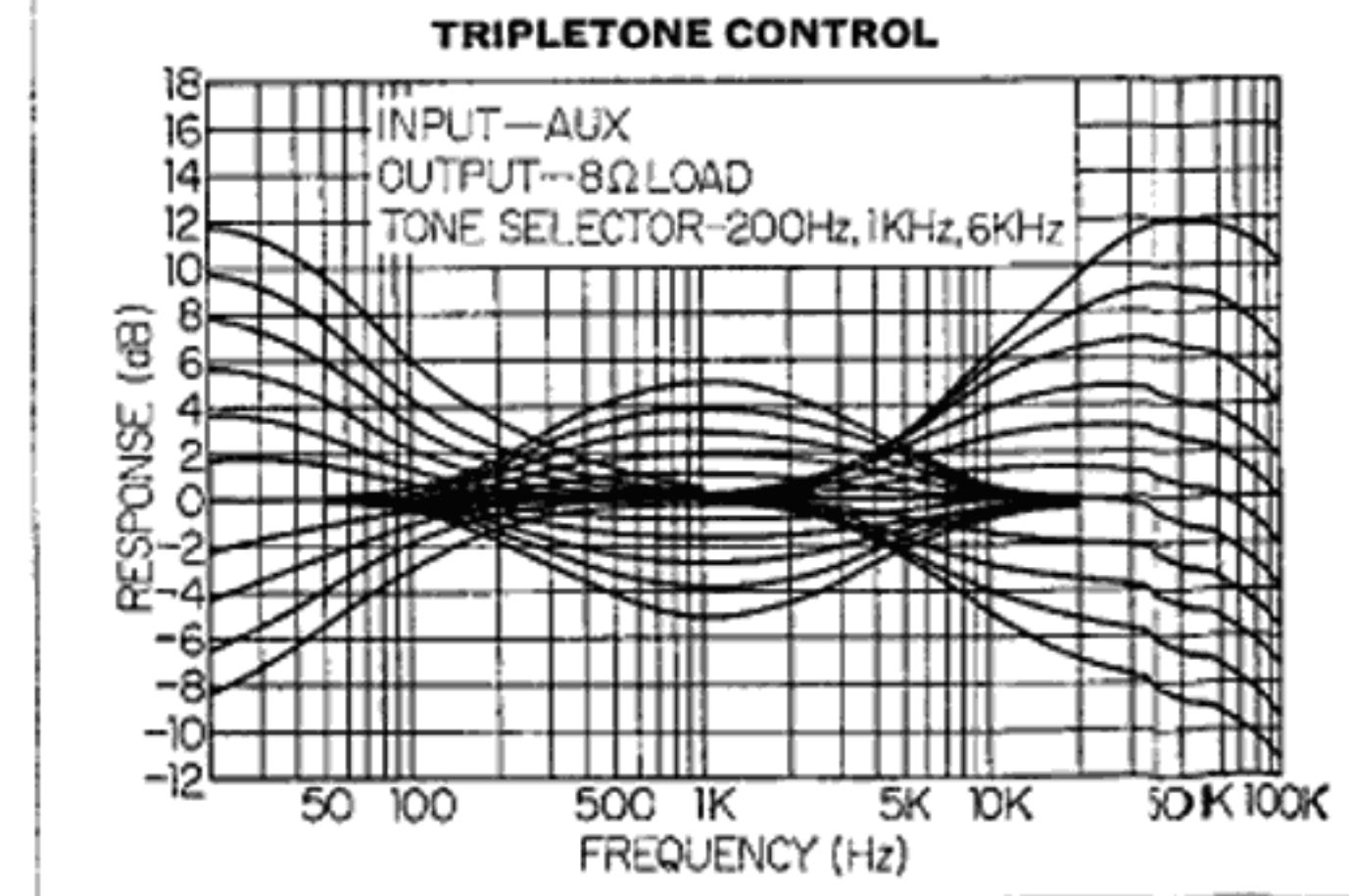
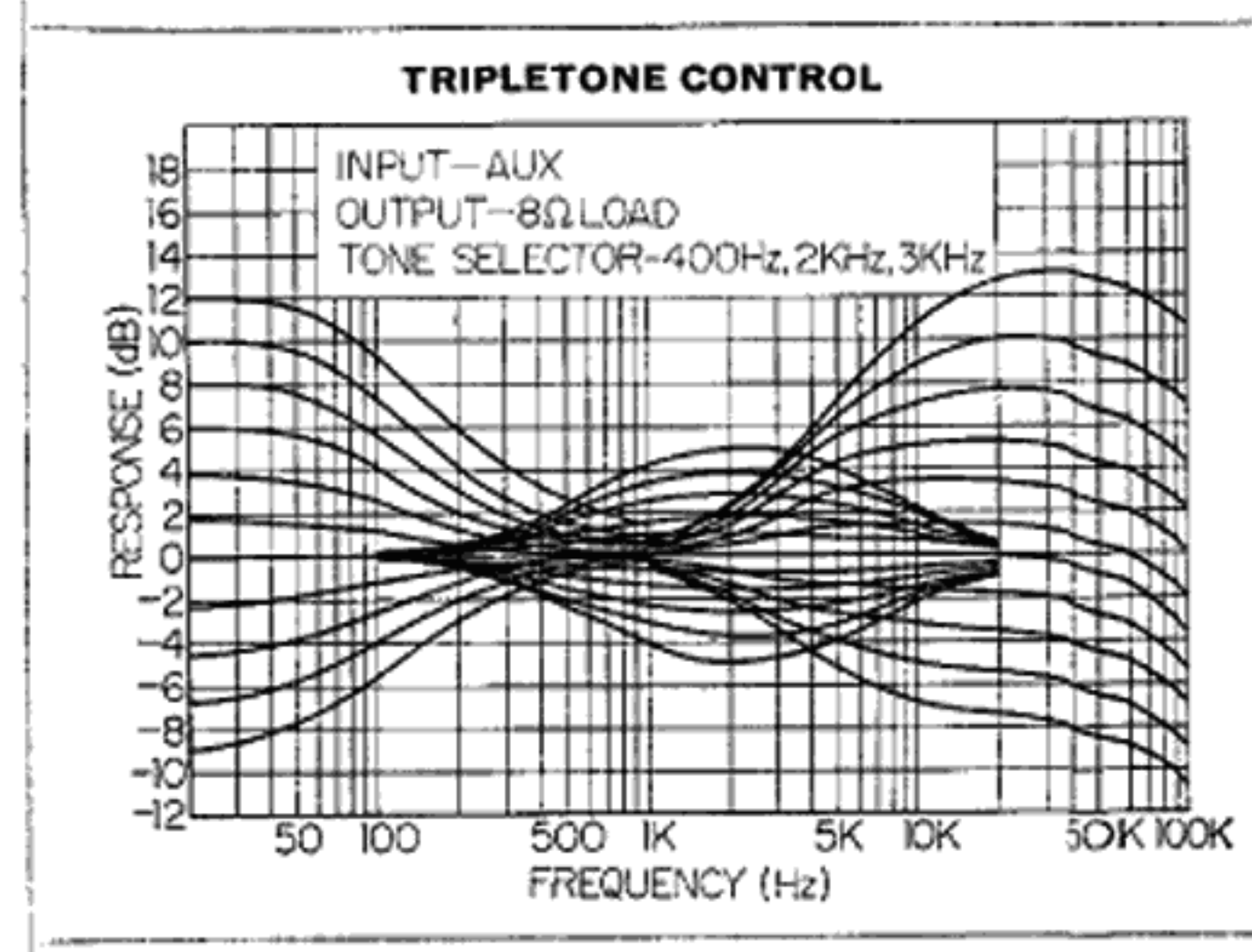
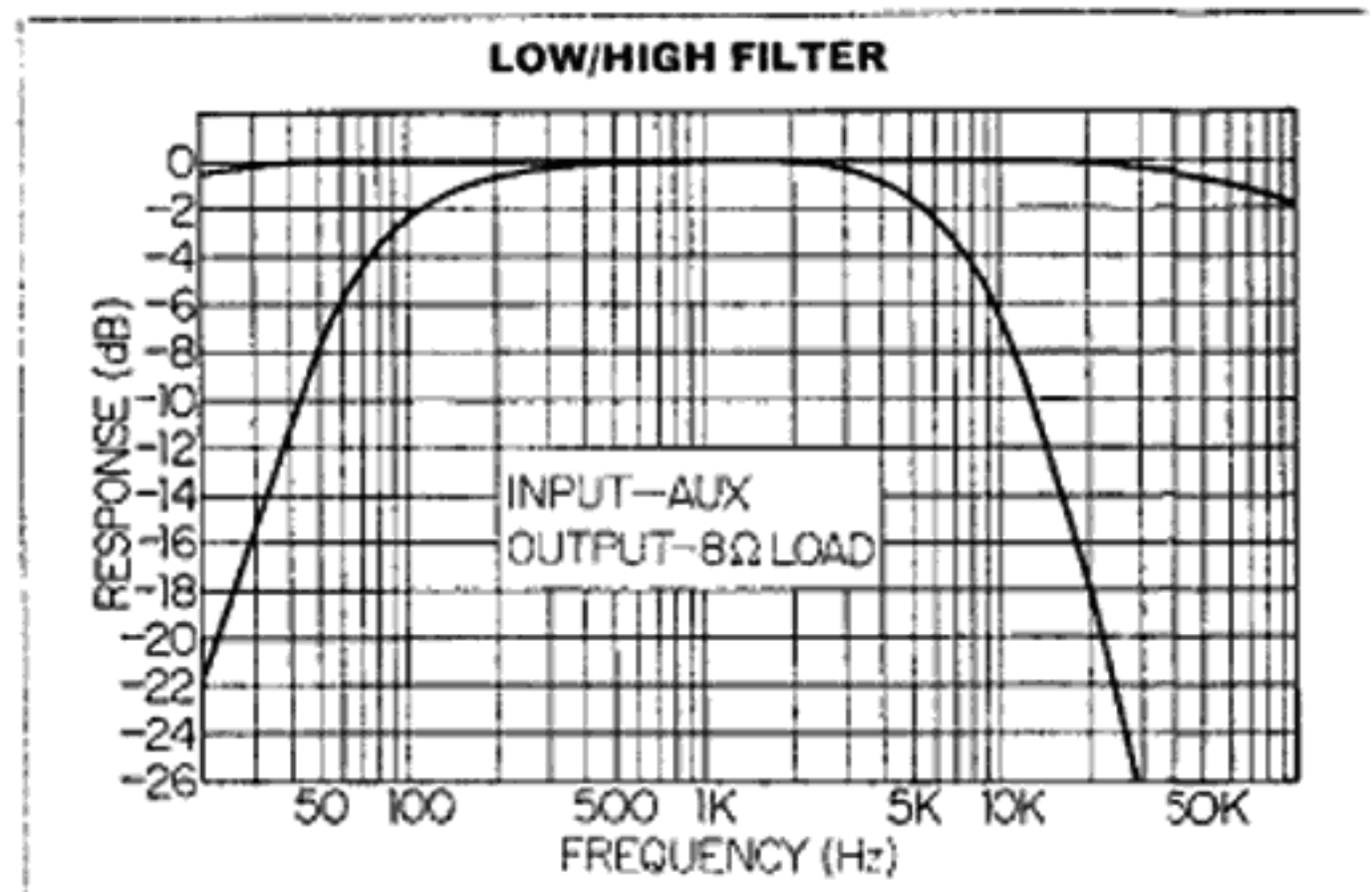
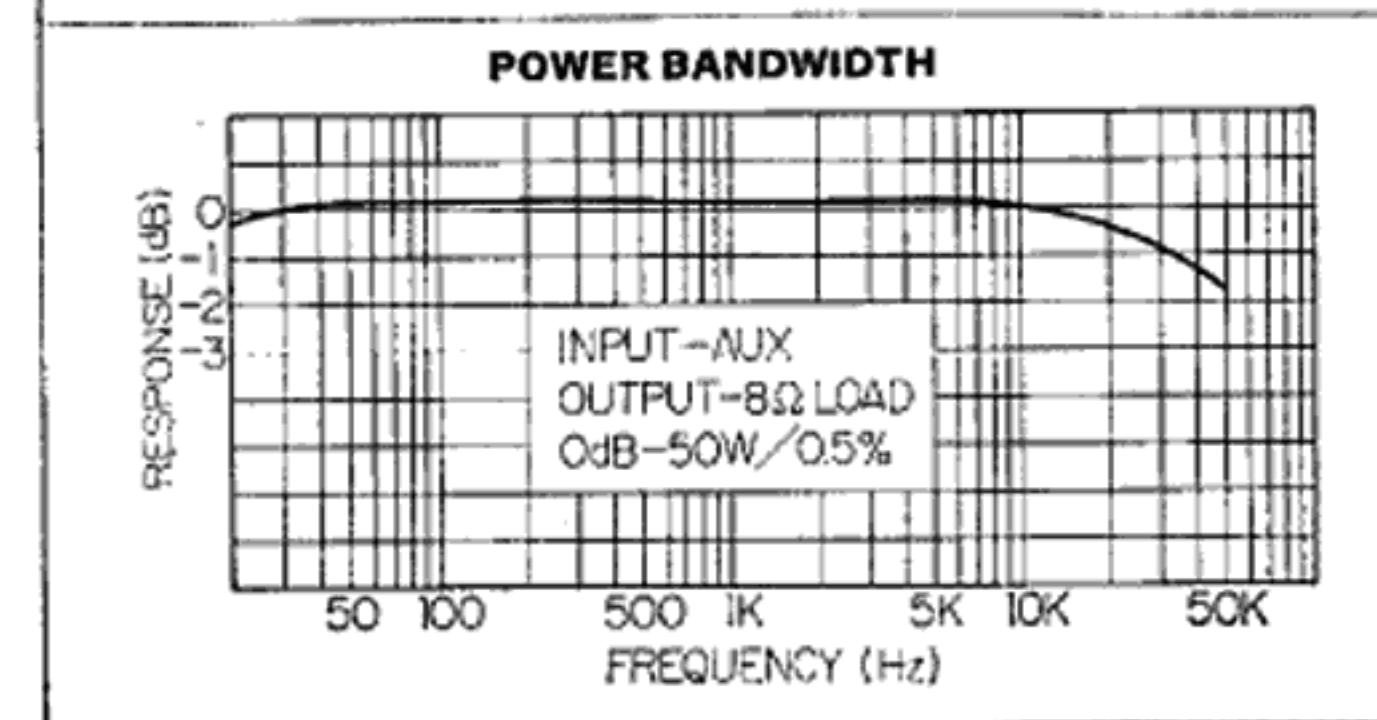
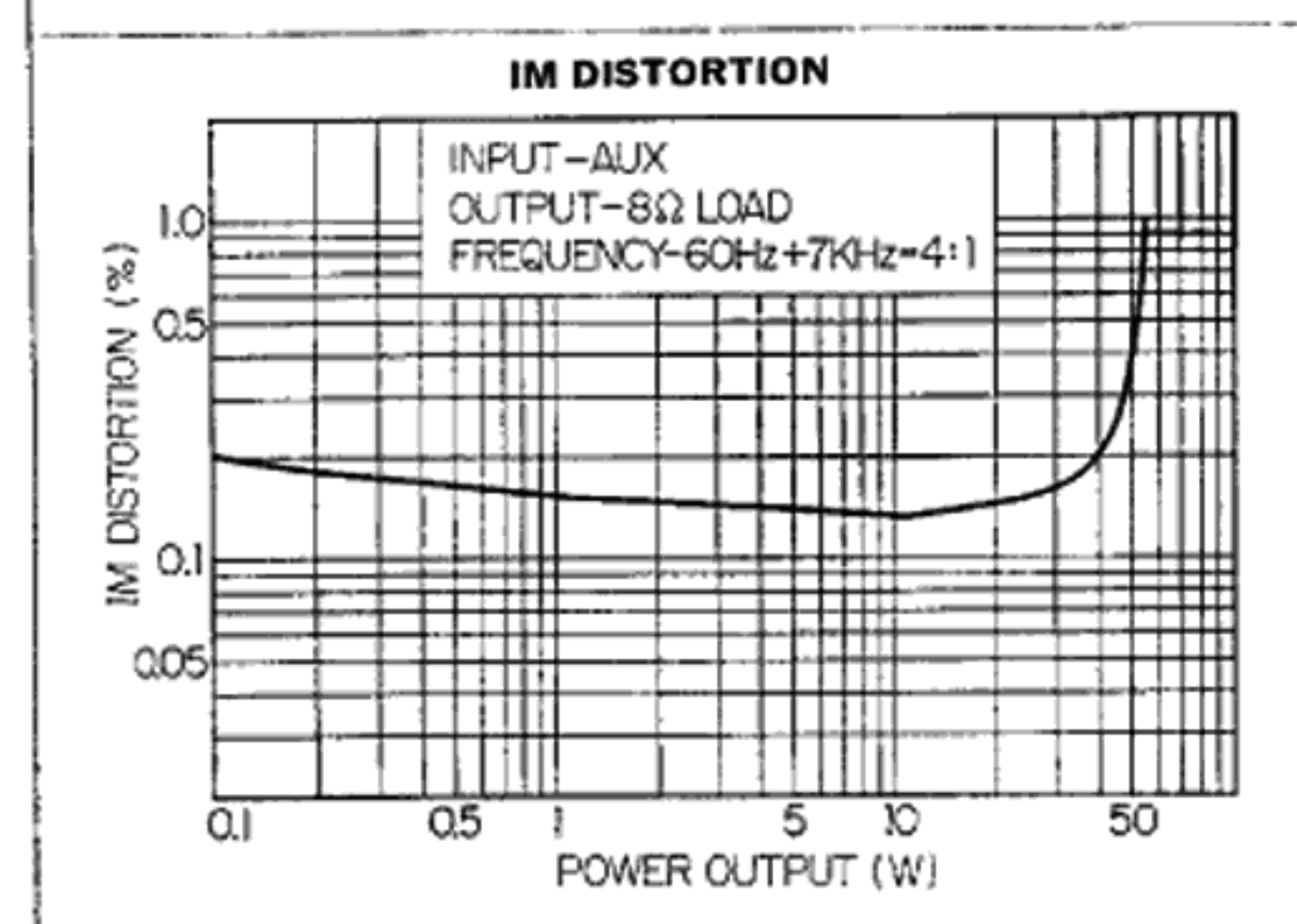
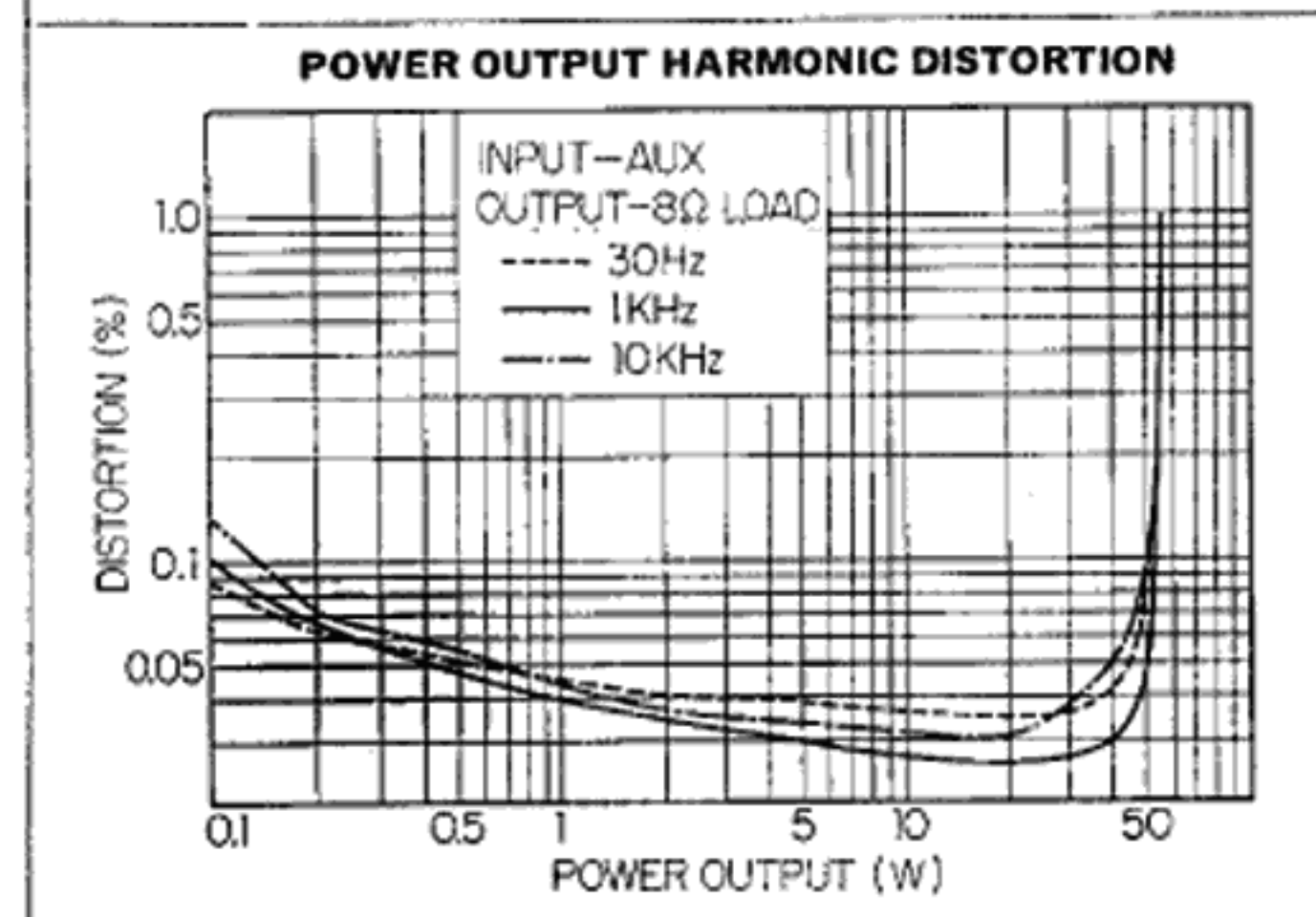
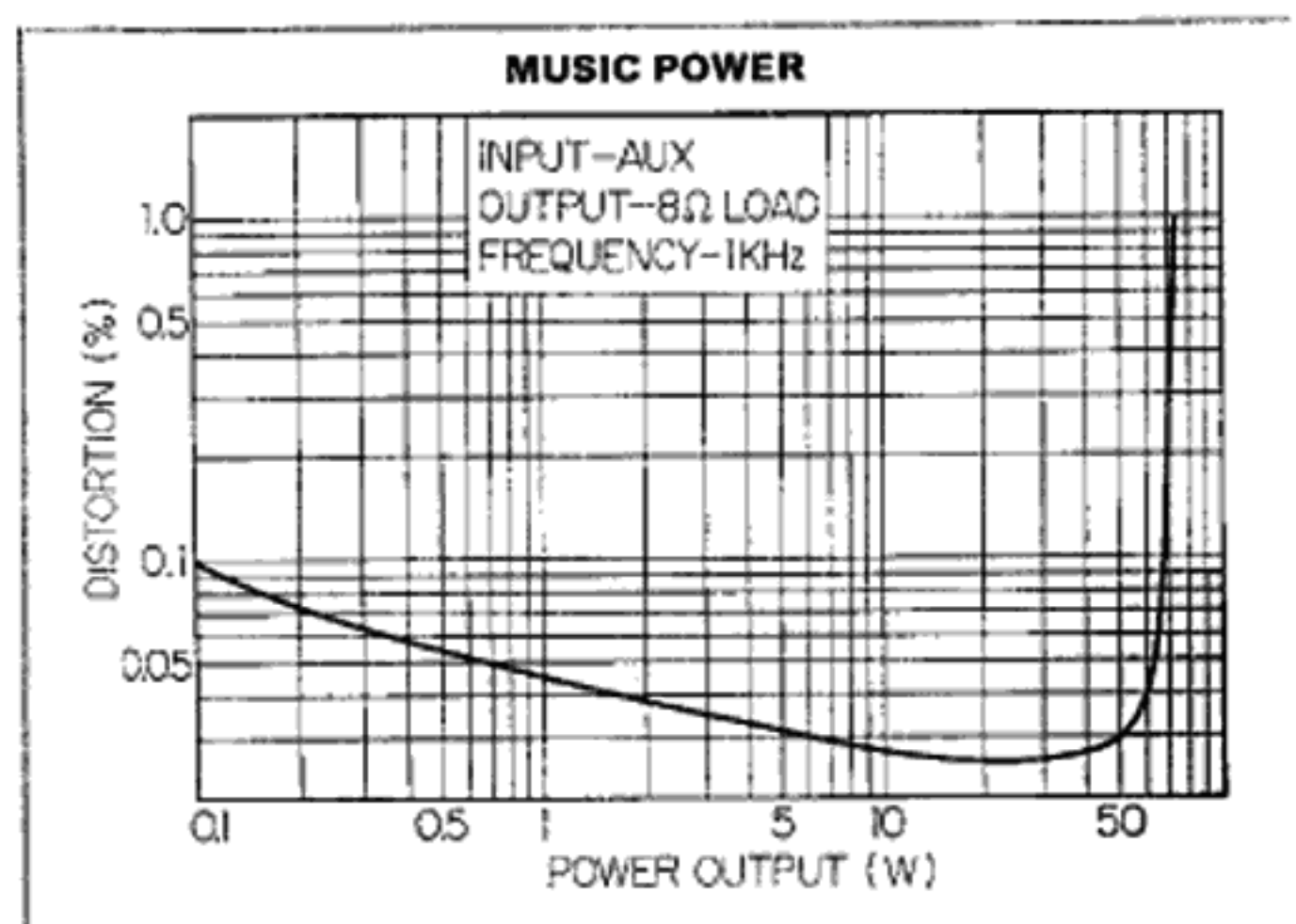

TROUBLESHOOTING CHART

If the amplifier is otherwise operating satisfactorily, the more common causes of trouble may generally be attributed to the following:

1. Incorrect connections or loose terminal contacts. Check the speakers, record player, tape deck antenna and line cord.
2. Improper operation. Before operating any audio components, be sure to read the manufacturer's instruc-

tions.

3. Improper location of audio components. The proper positioning of components, such as speakers and turntable, is vital to stereo.

4. Defective audio components.

The following are some other common causes of malfunction and what to do about them.

PROGRAM SOURCE	SYMPTOM	PROBABLE CAUSE	WHAT TO DO
Tuner	Contact or intermittent noise heard at certain times or in a certain area	<ul style="list-style-type: none"> * Discharge or oscillation caused by electrical appliances, such as fluorescent lamp, TV set, D.C. motor, rectifier and oscillator * Natural phenomena, such as atmospheric conditions, static, stray and thunderbolts * Insufficient antenna input due to reinforced concrete walls or long distance from the station * Wave interference from other electrical appliances 	<ul style="list-style-type: none"> * Attach a noise limiter to the electrical appliance that causes the noise, or attach it to the power source of the amplifier. * Install an outdoor antenna and ground the amplifier to raise the signal-to-noise ratio. * Reverse the power cord plug-receptacle connections. * If the noise occurs at a certain frequency, attach a wave trap to the ANT. input. * Keep the set at a proper distance from other electrical appliances.
	Noise heard at a particular time of a day, in a certain area or over part of the dial during AM reception	<ul style="list-style-type: none"> * This results from the nature of AM broadcast 	<ul style="list-style-type: none"> * Install the antenna for maximum antenna efficiency. * In some cases, the noise can be eliminated by grounding the amplifier or reversing the power cord plug-receptacle connections.
	High-frequency noise during AM reception	<ul style="list-style-type: none"> * Adjacent-channel interference or beat interference * TV set too close to the audio system 	<ul style="list-style-type: none"> * Although such noise cannot be eliminated by the amplifier, it is advisable to set the TREBLE control to the minimum counterclockwise position possible and switch on the HIGH FILTER. * Keep the TV set at a proper distance from the audio system.
	Noise during FM reception	<ul style="list-style-type: none"> * Poor noise limiter effect or too low S/N ratio due to insufficient antenna input <p>Note: FM reception is affected considerably by the broadcasting station's power and antenna efficiency. As a result, you may receive one station quite well while having difficulty in receiving another station.</p>	<ul style="list-style-type: none"> * Install the antenna for maximum signal strength. * If this does not prove effective, use an outdoor antenna designed exclusively for FM. When you use a TV antenna for both TV and FM with the help of a divider, make sure the TV reception is not affected. * An excessive long antenna may cause noise.
	A series of pops	<ul style="list-style-type: none"> * Ignition noise caused by an auto, motorcycle or the like 	<ul style="list-style-type: none"> * Keep the antenna and its lead-in wire away from heavy traveled roads or raise the antenna input.

PROGRAM SOURCE	SYMPTOM	PROBABLE CAUSE	WHAT TO DO
(continued)	Noise heard during FM stereo, but not heard during FM mono reception.	* The service area of the FM stereo broadcast is only half that of the FM mono broadcast.	* Install the antenna for maximum antenna input. * Switch on the HIGH FILTER and/or set the TREBLE control to the minimum counterclockwise position possible.
Record player, tape recorder or tape deck	Hum or howling	* Record player placed directly on the speaker box * Use of wire other than shielded wire * Loose terminal contact * Shielded wire too close to the line cord, fluorescent lamp or other electrical appliances * Nearby amateur radio station or TV transmission antenna	* Put a cushion under the record player. * Experiment with several different arrangements before deciding on the final positions of the speaker and record player. * Use a shielded cord for connections. * Switch on the LOW FILTER. * The connecting cord should be as short as possible. * Don't raise the BASS loudness too much. * Consult the nearest Radio Regulatory Bureau.
	Surface noise	* Worn or old record * Worn pick-up needle * Needle covered with dust * Improper needle pressure	* Set the TREBLE control to the minimum counterclockwise position possible and/or switch on the HIGH FILTER. * Clean or replace the needle.
Common to all program sources	The BALANCE control is not in the mid-position when equal sound comes from both left and right channels.	* Due to imperfections in program material, variations in speaker output or asymmetry in room acoustics, the BALANCE control is not always set to the mid-position.	* Set the MODE switches to MONO and adjust the BALANCE control so that the sound is heard from a point midway between the two speakers.

CUSTOM MOUNTING

How to Install the Amplifier in a Wooden Cabinet

1. As illustrated right, make a cabinet window of 450mm or $17\frac{23}{32}$ " in width and 145mm or $5\frac{45}{64}$ " in height.
2. Place two square pieces of wood ($20 \times 20 \times 270$ mm or $\frac{25}{32}$ " \times $\frac{25}{32}$ " \times $10\frac{5}{8}$ ") for supporting the amplifier in the bottom board of the cabinet.
3. Cut two holes for attachment bolts in the bottom board of the cabinet.
4. Remove the four rubber feet from the amplifier.
5. Place the amplifier in position through the cabinet window.
6. Make sure the amplifier is in position, then put the washers in butterfly bolts (supplied) and fix the amplifier to the cabinet with butterfly bolts.

Note:

When the amplifier is built into the cabinet, the four rubber feet are not used. Retain them for future use.

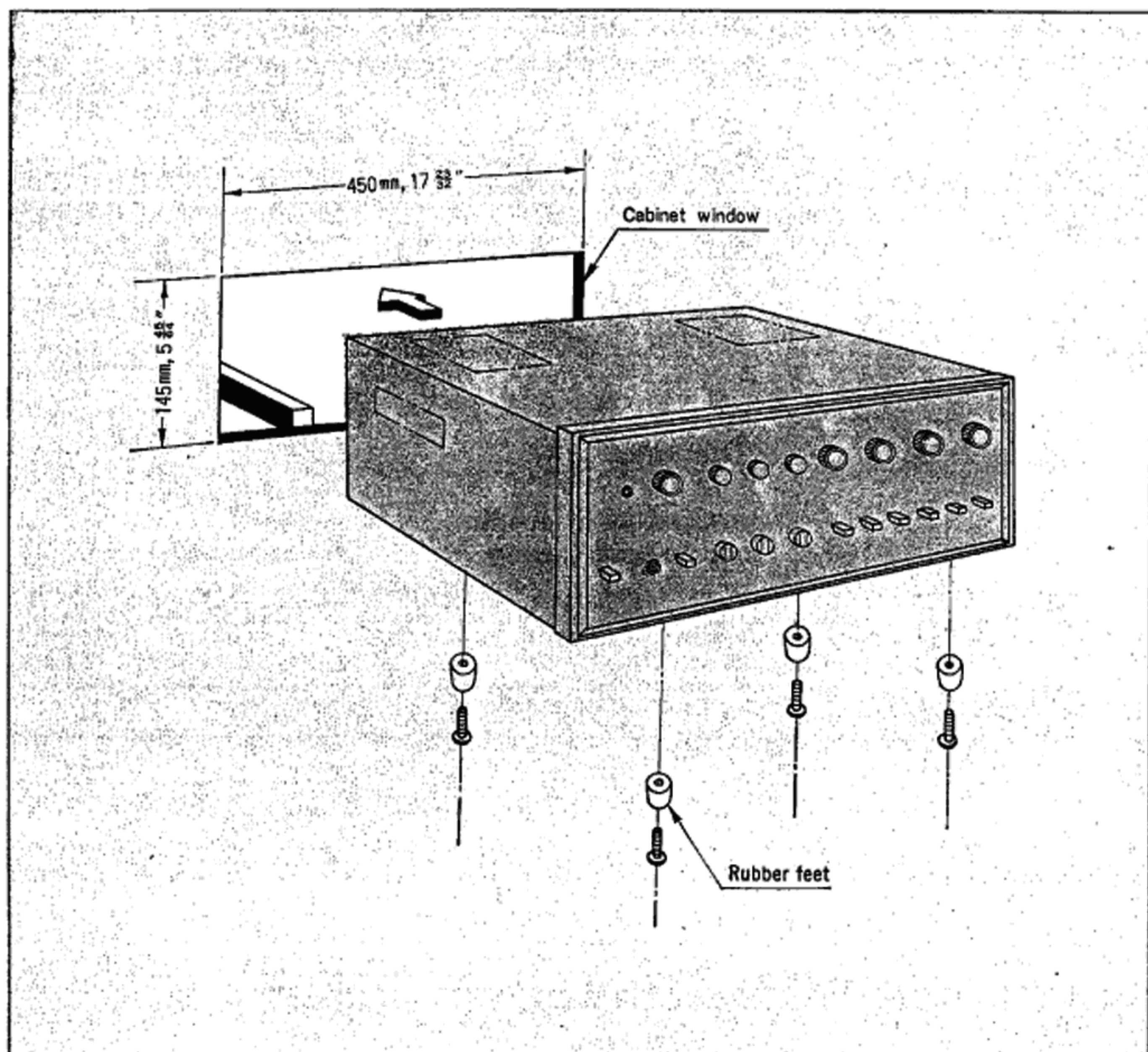

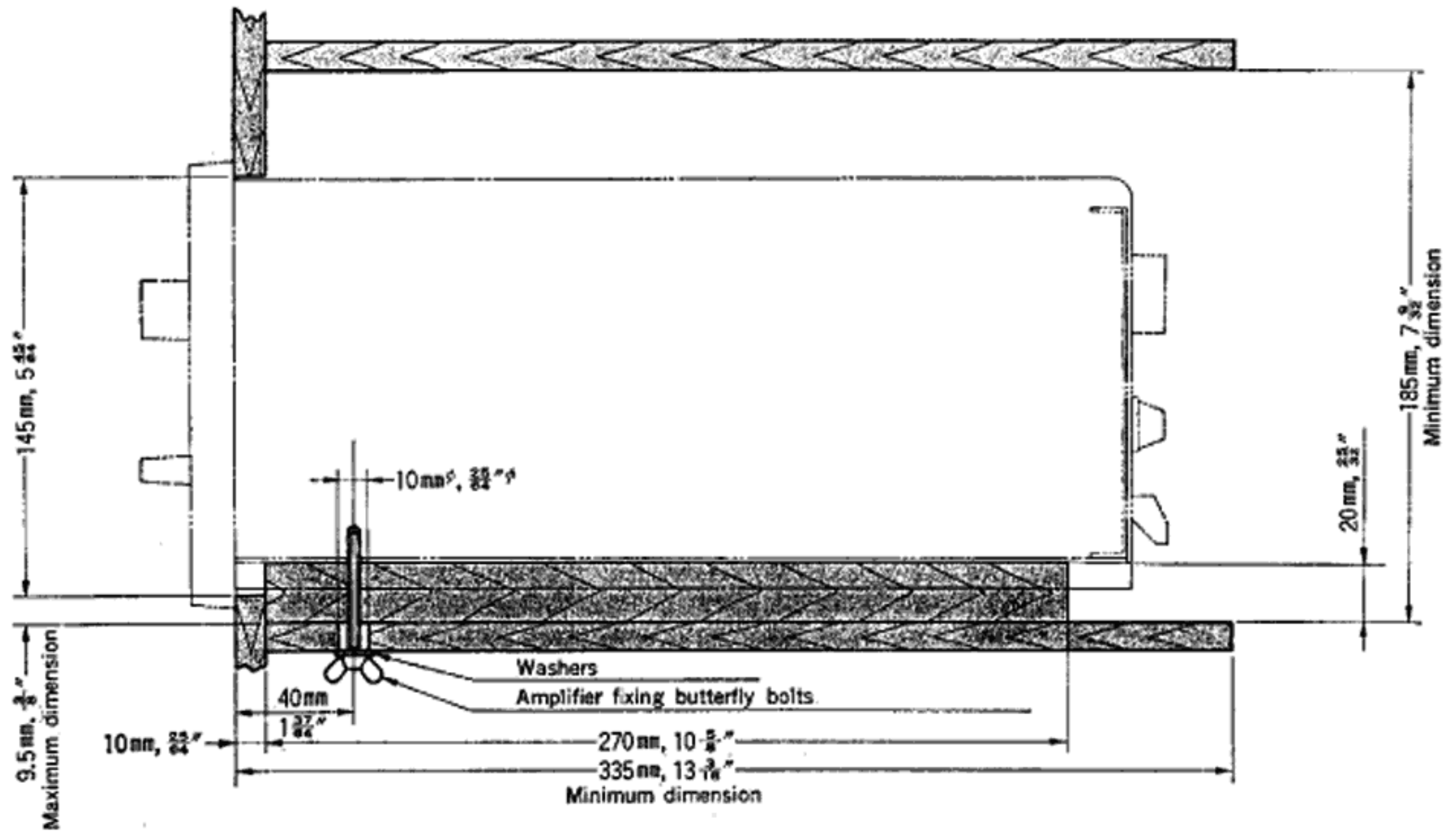
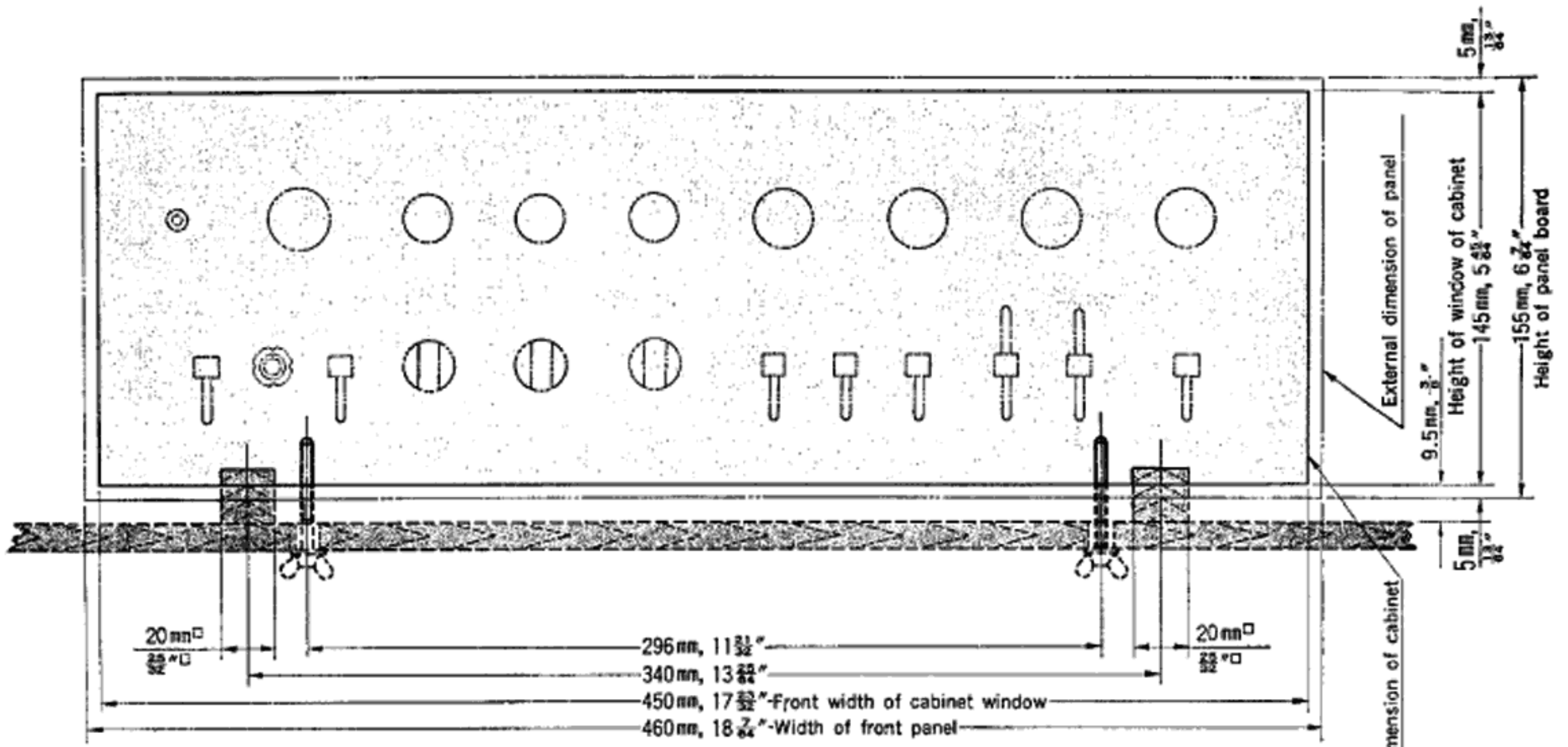

DIASSEMBLY PROCEDURE

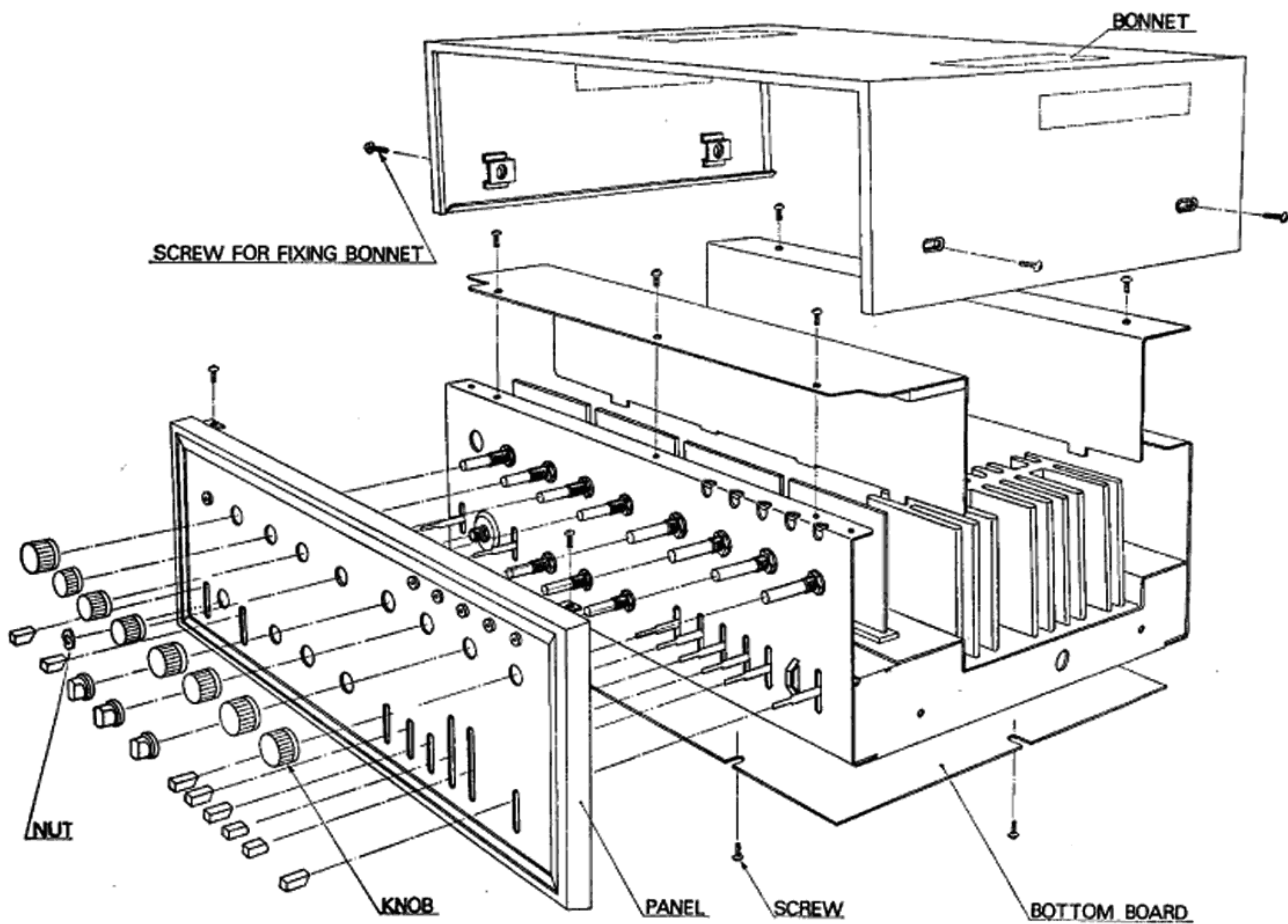

BLOCK DIAGRAM / LEVEL DIAGRAM

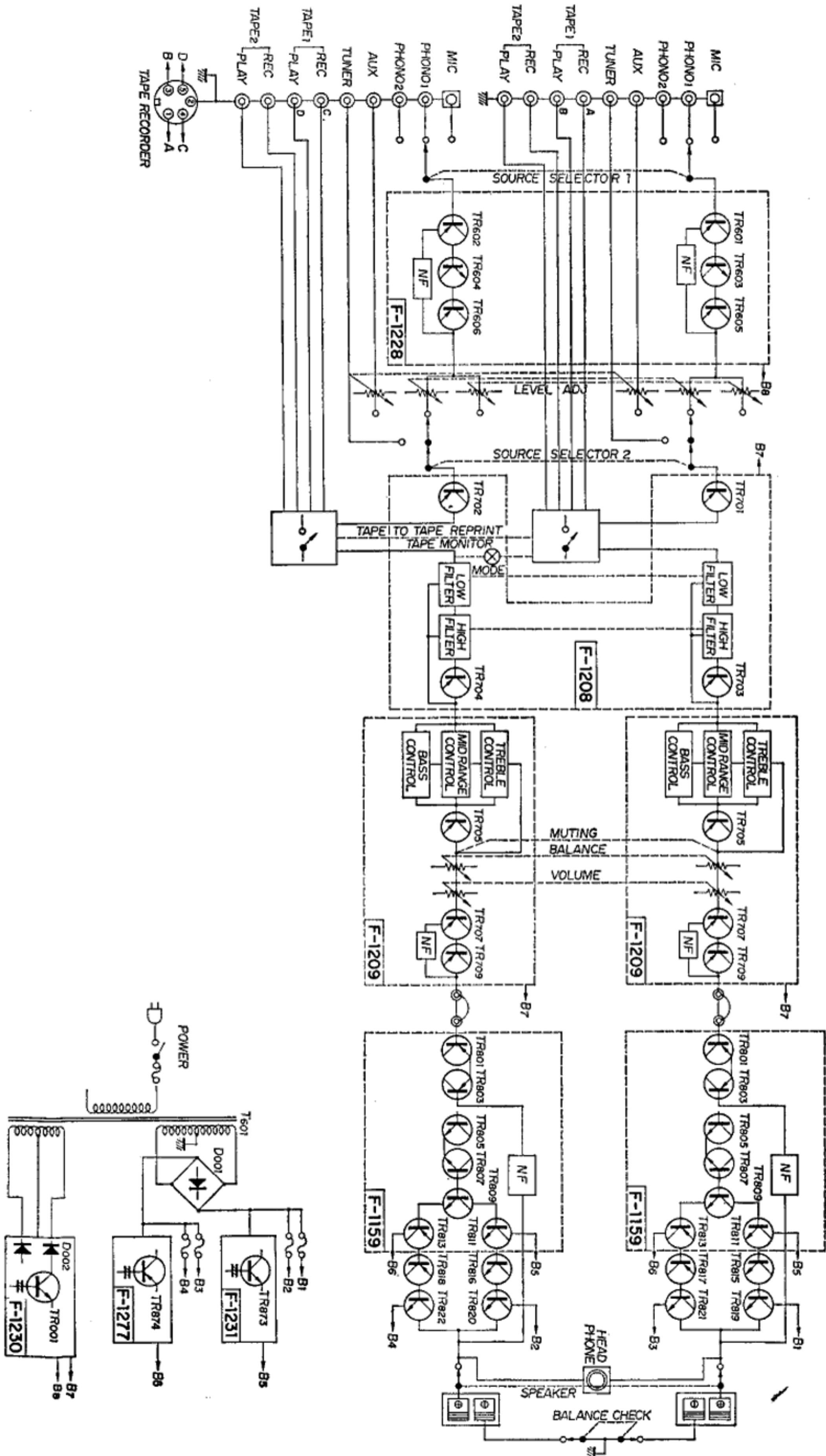

LEVEL DIAGRAM

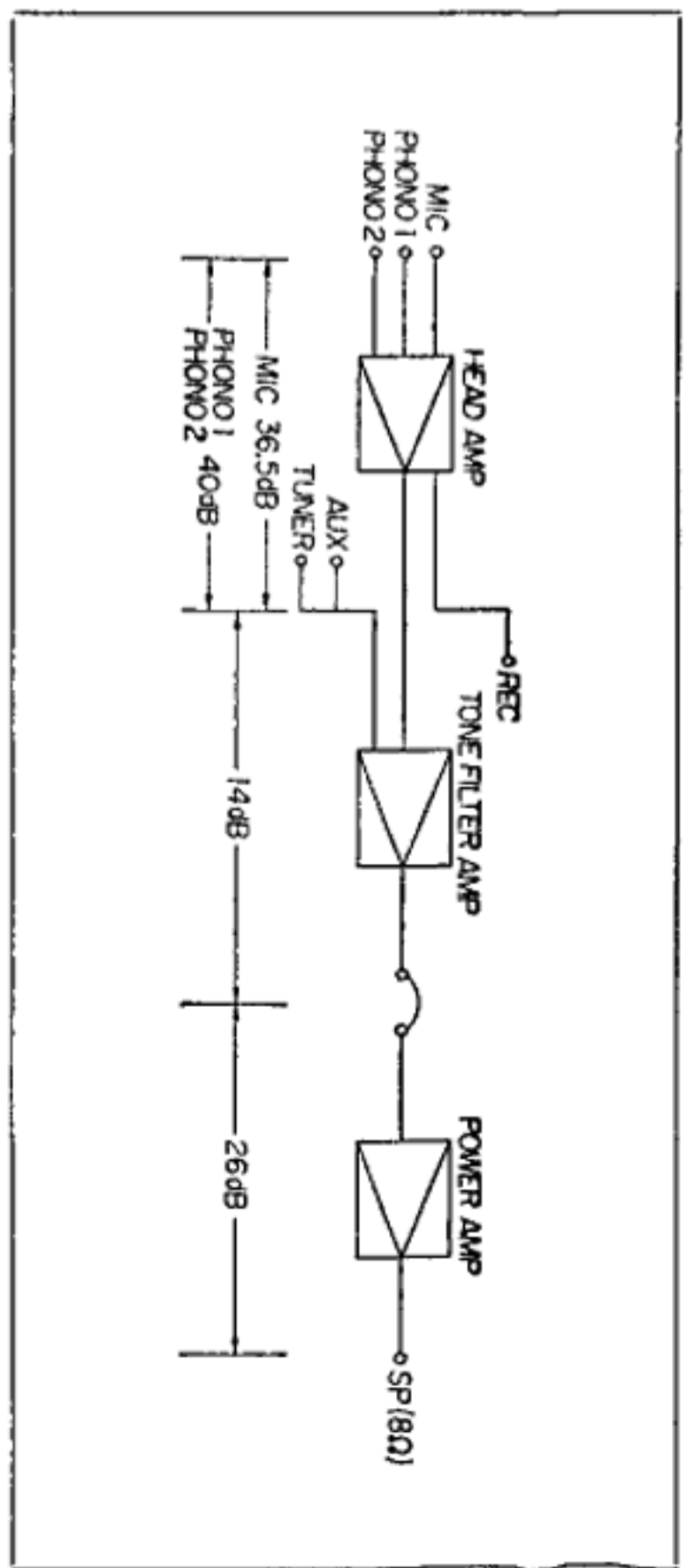

ALIGNMENT

TEST POINTS

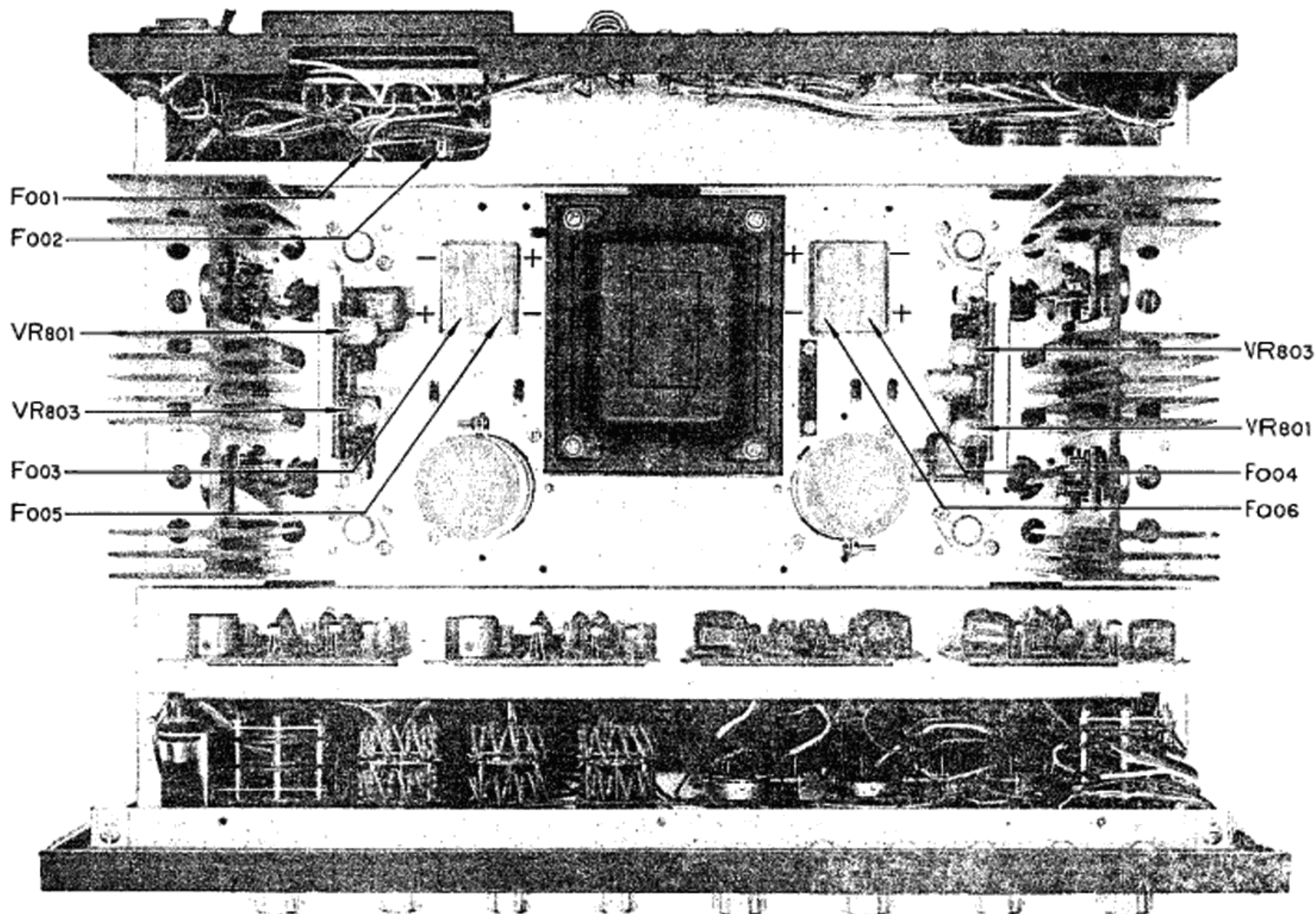

MAIN-AMP. SECTION OUTPUT BALANCE ADJUSTMENT

STEP	WHAT TO DO	REMARKS
1.	Connect an 8 to 16-ohm load resistor to the left-channel SYSTEM A speaker terminal.	
2.	Connect a voltmeter in parallel with the load resistor.	The Voltmeter should be used in the 0.5~3V range.
3.	Turn SPEAKERS switch to SYSTEM A.	
4.	Turn POWER switch on.	
5.	Adjust VR ₈₀₁ so that the voltage will be kept within 0±50mV.	
	For the right channel, follow the same procedures as above. In Step 5, VR ₈₀₂ should be adjusted.	

MAIN-AMP. SECTION CURRENT ADJUSTMENT

STEP	AMMETER (TESTER)	WHAT TO DO	REMARKS
1.		Remove F ₀₀₃ and F ₀₀₄ .	Ammeter required: 100mA or 50mA range
2.		Set VR ₈₀₃ and VR ₈₀₄ to minimum clockwise position.	
3.		Turn POWER switch ON.	
4.	Set to 100mA range.	Set ammeter in place of F ₀₀₃ . Connect its ⊕ terminal to 27, and its ⊖ terminal to B ₁ in schematic diagram.	Be sure to turn POWER switch on and then connect ammeter.
5.		Turn VR ₈₀₃ and adjust current to 28~32mA.	
6.		Turn POWER switch OFF and reset F ₀₀₃ to its original position.	
7.	Set to 100mA range.	Turn POWER switch ON and set ammeter in place of F ₀₀₂ . Connect its ⊕ terminal to 27, and its ⊖ terminal to B ₂ .	
8.		Turn VR ₈₀₄ and adjust current to 28~32mA.	
9.		Turn POWER switch OFF, and attach F ₀₀₃ and F ₀₀₄ .	

PRINTED CIRCUIT BOARDS AND PARTS LIST

HEAD AMP. BLOCK (F-1228-1)

X	Y	Z
R601	220kΩ ±10% ¼W Carbon Resistor (R)	2 B
R602	220kΩ ±10% ¼W Carbon Resistor (R)	2 A
R603	220kΩ ±10% ¼W Carbon Resistor (R)	1 B
R604	220kΩ ±10% ¼W Carbon Resistor (R)	1 A
R605	1kΩ ±10% ¼W Carbon Resistor (R)	2 B
R606	1kΩ ±10% ¼W Carbon Resistor (R)	2 A
R607	1MΩ ±10% ¼W Carbon Resistor (R)	1 B
R608	1MΩ ±10% ¼W Carbon Resistor (R)	1 A
R609	3.3kΩ ±10% ¼W Carbon Resistor (R)	1 B
R610	3.3kΩ ±10% ¼W Carbon Resistor (R)	1 A
R611	39kΩ ±10% ¼W Carbon Resistor (R)	1 B
R612	39kΩ ±10% ¼W Carbon Resistor (R)	1 A
R613	22kΩ ±10% ¼W Carbon Resistor (R)	1 B
R614	22kΩ ±10% ¼W Carbon Resistor (R)	1 A
R615	47kΩ ±10% ¼W Carbon Resistor (R)	1 B
R616	47kΩ ±10% ¼W Carbon Resistor (R)	1 A
R617	3.3kΩ ±10% ¼W Carbon Resistor (R)	1 B
R618	3.3kΩ ±10% ¼W Carbon Resistor (R)	1 A
R619	470kΩ ±10% ¼W Carbon Resistor (R)	1 B
R620	470kΩ ±10% ¼W Carbon Resistor (R)	1 A
R621	180Ω ±10% ¼W Carbon Resistor (R)	1 B
R622	180Ω ±10% ¼W Carbon Resistor (R)	1 A
R623	10kΩ ±10% ¼W Carbon Resistor (R)	2 B
R624	10kΩ ±10% ¼W Carbon Resistor (R)	2 A
R625	470Ω ±10% ¼W Carbon Resistor (R)	2 B
R626	470Ω ±10% ¼W Carbon Resistor (R)	2 A
R627	39kΩ ±10% ¼W Carbon Resistor (R)	2 B
R628	39kΩ ±10% ¼W Carbon Resistor (R)	2 A
R629	33kΩ ±10% ¼W Carbon Resistor (R)	2 B
R630	33kΩ ±10% ¼W Carbon Resistor (R)	2 A
R631	33kΩ ±10% ¼W Carbon Resistor (R)	2 B

X	Y	Z
R632	33kΩ ±10% ¼W Carbon Resistor (R)	2 A
R633	100Ω ±10% ¼W Carbon Resistor (R)	2 A
R634	100Ω ±10% ¼W Carbon Resistor (R)	2 B
R653	56kΩ ±10% ¼W Carbon Resistor (R)	1 A, B
C601	0.47μF ±10% 50 WV Mylar Capacitor	1 B
C602	0.47μF ±10% 50 WV Mylar Capacitor	1 A
C603	10μF 25WV Electrolytic Capacitor	2 B
C604	10μF 25WV Electrolytic Capacitor	2 A
C605	33pF ±10% 50 WV Ceramic Capacitor	1 B
C606	33pF ±10% 50 WV Ceramic Capacitor	1 A
C607	47μF 10 WV Electrolytic Capacitor	1 B
C608	47μF 10 WV Electrolytic Capacitor	1 A
C609	33μF 6.3 WV Electrolytic Capacitor	2 B
C610	33μF 6.3 WV Electrolytic Capacitor	2 A
C611	470pF ±10% 50 WV Ceramic Capacitor	2 B
C612	470pF ±10% 50 WV Ceramic Capacitor	2 A
C613	0.47μF ±10% 50 WV Mylar Capacitor	2 B
C614	0.47μF ±10% 50 WV Mylar Capacitor	2 A
C615	0.006μF ±10% 50 WV Mylar Capacitor	2 B
C616	0.006μF ±10% 50 WV Mylar Capacitor	2 A
C617	0.0022μF ±10% 50 WV Mylar Capacitor	2 B
C618	0.0022μF ±10% 50 WV Mylar Capacitor	2 A
C619	56pF ±10% 50 WV Ceramic Capacitor	2 B
C620	56pF ±10% 50 WV Ceramic Capacitor	2 A
C621	33μF 50 WV Electrolytic Capacitor	1 A, B
TR601	XA495BL(C) Silicon Transistor 030016-2	1 B
TR602	XA495BL(C) Silicon Transistor 030016-2	1 A
TR603	2SC458LG(B) Silicon Transistor 030531-3	1 B
TR604	2SC453LG(B) Silicon Transistor 030531-3	1 A
TR605	XA495BL(B, C, D) Silicon Transistor 030016-1~3	1 B
TR606	XA495BL(B, C, D) Silicon Transistor 030016-1~3	1 A

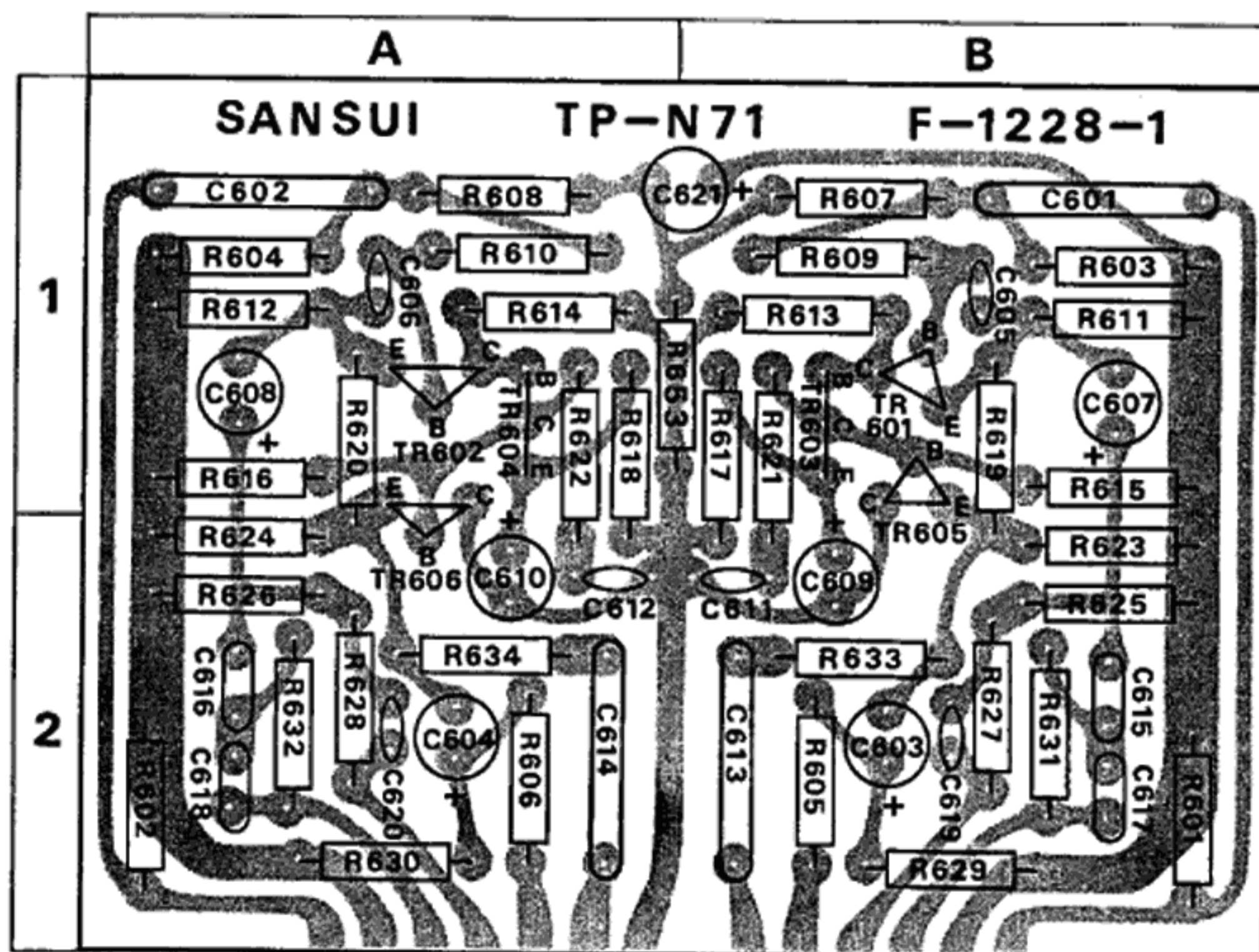

TONE CONTROL BLOCK <F-1209>

X	Y	Z
R735	100kΩ ±10% ¼W Carbon Resistor (R)	2 A
R737	10kΩ ±10% ¼W Carbon Resistor (R)	2 B
R739	8.2kΩ ±10% ¼W Carbon Resistor (R)	2 B
R741	8.2kΩ ±10% ¼W Carbon Resistor (R)	2 B
R743	2.2kΩ ±10% ¼W Carbon Resistor (R)	2 B
R745	10kΩ ±10% ¼W Carbon Resistor (R)	2 B
R747	12kΩ ±10% ¼W Carbon Resistor (R)	2 B
R749	8.2kΩ ±10% ¼W Carbon Resistor (R)	2 A
R751	8.2kΩ ±10% ¼W Carbon Resistor (R)	2 A
R753	12kΩ ±10% ¼W Carbon Resistor (R)	2 B
R755	470kΩ ±10% ¼W Carbon Resistor (R)	1 B
R757	330kΩ ±10% ¼W Carbon Resistor (R)	1 B
R759	5.6kΩ ±10% ¼W Carbon Resistor (R)	1 A
R761	3.3kΩ ±10% ¼W Carbon Resistor (R)	1 B
R763	4.7kΩ ±10% ¼W Carbon Resistor (R)	1 A
R765	100kΩ ±10% ¼W Carbon Resistor (R)	1 A
R767	47kΩ ±10% ¼W Carbon Resistor (R)	1 A
R769	1.5kΩ ±10% ¼W Carbon Resistor (R)	2 A
R771	5.6kΩ ±10% ¼W Carbon Resistor (R)	1 A
R773	820Ω ±10% ¼W Carbon Resistor (R)	2 A

X	Y	Z
R775	15kΩ ±10% ¼W Carbon Resistor (R)	1 A
C719	10μF 25 WV Electrolytic Capacitor	2 A
C721	0.47μF ±10% 50 WV Mylar Capacitor	1, 2 B
C723	47μF 10 WV Electrolytic Capacitor	1, 2 B
C725	0.47μF ±10% 50 WV Mylar Capacitor	2 A
C727	0.47μF ±10% 50 WV Mylar Capacitor	2 A
C729	33μF 25 WV Electrolytic Capacitor	2 A
C731	33pF ±10% 50 WV Ceramic Capacitor	1 A
C733	47μF 10 WV Electrolytic Capacitor	2 A
C735	10μF 25 WV Electrolytic Capacitor	1 A
C737	0.1μF ±10% 50 WV Mylar Capacitor	1, 2 A
L701	0.8H Choke Coil (401003)	1 B
TR705	XA495BL (B, C, D) Silicon Transistor 030016-1~3	1 B
TR707	XA495BL (B, C, D) Silicon Transistor	1 A
TR709	XA495BL (B) Silicon Transistor 030016-1~3 030016-1	1 A

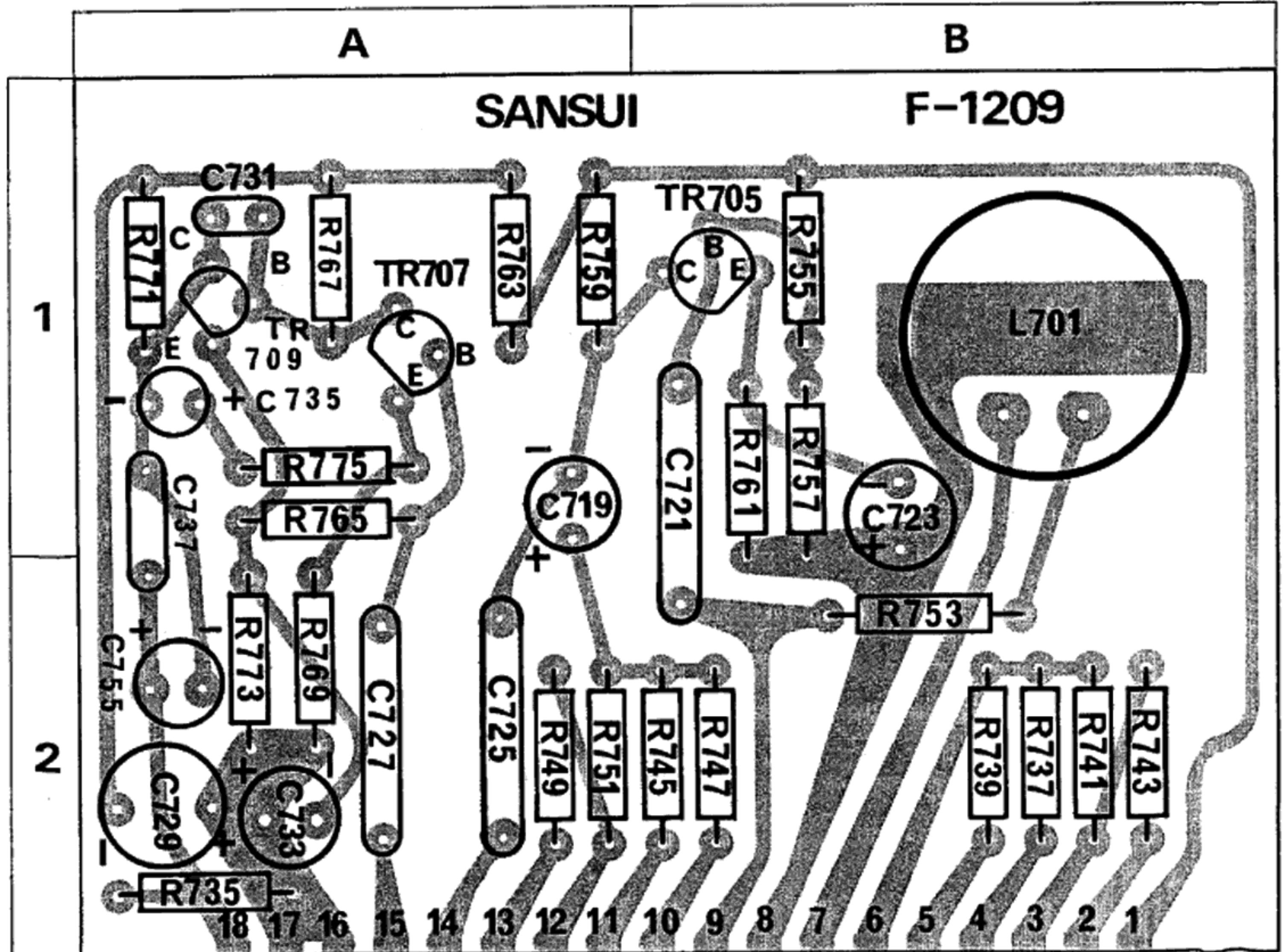

FILTER BLOCK <F-1208>

X	Y	Z
R701	470kΩ ±10% ¼W Carbon Resistor (R)	2 B
R702	470kΩ ±10% ¼W Carbon Resistor (R)	2 A
R703	1MΩ ±10% ¼W Carbon Resistor (R)	2 B
R704	1MΩ ±10% ¼W Carbon Resistor (R)	2 A
R705	2.2kΩ ±10% ¼W Carbon Resistor (R)	1 B
R706	2.2kΩ ±10% ¼W Carbon Resistor (R)	1 A
R707	8.2kΩ ±10% ¼W Carbon Resistor (R)	1 B
R708	8.2kΩ ±10% ¼W Carbon Resistor (R)	1 A
R709	1MΩ ±10% ¼W Carbon Resistor (R)	2 B
R710	1MΩ ±10% ¼W Carbon Resistor (R)	2 A
R711	1MΩ ±10% ¼W Carbon Resistor (R)	2 B
R712	1MΩ ±10% ¼W Carbon Resistor (R)	2 A
R713	39kΩ ±10% ¼W Carbon Resistor (R)	2 B
R714	39kΩ ±10% ¼W Carbon Resistor (R)	2 A
R715	100kΩ ±10% ¼W Carbon Resistor (R)	2 B
R716	100kΩ ±10% ¼W Carbon Resistor (R)	2 A
R717	6.8kΩ ±10% ¼W Carbon Resistor (R)	2 B
R718	6.8kΩ ±10% ¼W Carbon Resistor (R)	2 A
R719	15kΩ ±10% ¼W Carbon Resistor (R)	1 B
R720	15kΩ ±10% ¼W Carbon Resistor (R)	1 A
R721	470kΩ ±10% ¼W Carbon Resistor (R)	1 B
R722	470kΩ ±10% ¼W Carbon Resistor (R)	1 A
R725	1MΩ ±10% ¼W Carbon Resistor (R)	1 B
R726	1MΩ ±10% ¼W Carbon Resistor (R)	1 A
R727	8.2kΩ ±10% ¼W Carbon Resistor (R)	1 B
R728	8.2kΩ ±10% ¼W Carbon Resistor (R)	1 A

X	Y	Z
R729	470Ω ±10% ¼W Carbon Resistor (R)	1 B
R730	470Ω ±10% ¼W Carbon Resistor (R)	1 A
R731	100kΩ ±10% ¼W Carbon Resistor (R)	2 B
R732	100kΩ ±10% ¼W Carbon Resistor (R)	2 A
C701	0.47μF ±10% 50 WV Mylar Capacitor	2 B
C702	0.47μF ±10% 50 WV Mylar Capacitor	2 A
C703	0.47μF ±10% 50 WV Mylar Capacitor	1 B
C704	0.47μF ±10% 50 WV Mylar Capacitor	1 A
C705	0.08μF ±10% 50 WV Mylar Capacitor	2 B
C706	0.08μF ±10% 50 WV Mylar Capacitor	2 A
C707	0.033μF ±10% 50 WV Mylar Capacitor	2 B
C708	0.033μF ±10% 50 WV Mylar Capacitor	2 A
C709	0.0022μF ±10% 50 WV Mylar Capacitor	2 B
C710	0.0022μF ±10% 50 WV Mylar Capacitor	2 A
C711	0.47μF ±10% 50 WV Mylar Capacitor	1 B
C712	0.47μF ±10% 50 WV Mylar Capacitor	1 A
C713	0.001μF ±10% 50 WV Mylar Capacitor	2 B
C714	0.001μF ±10% 50 WV Mylar Capacitor	2 A
C715	0.047μF ±10% 50 WV Mylar Capacitor	2 B
C716	0.047μF ±10% 50 WV Mylar Capacitor	2 A
TR701	XA495BL (B, C, D) 030016-1~3	1 B
TR702	XA495BL (B, C, D) 030016-1~3	1 A
TR703	XA495BL (B, C, D) 030016-1~3	1 B
TR704	XA495BL (B, C, D) 030016-1~3	1 A

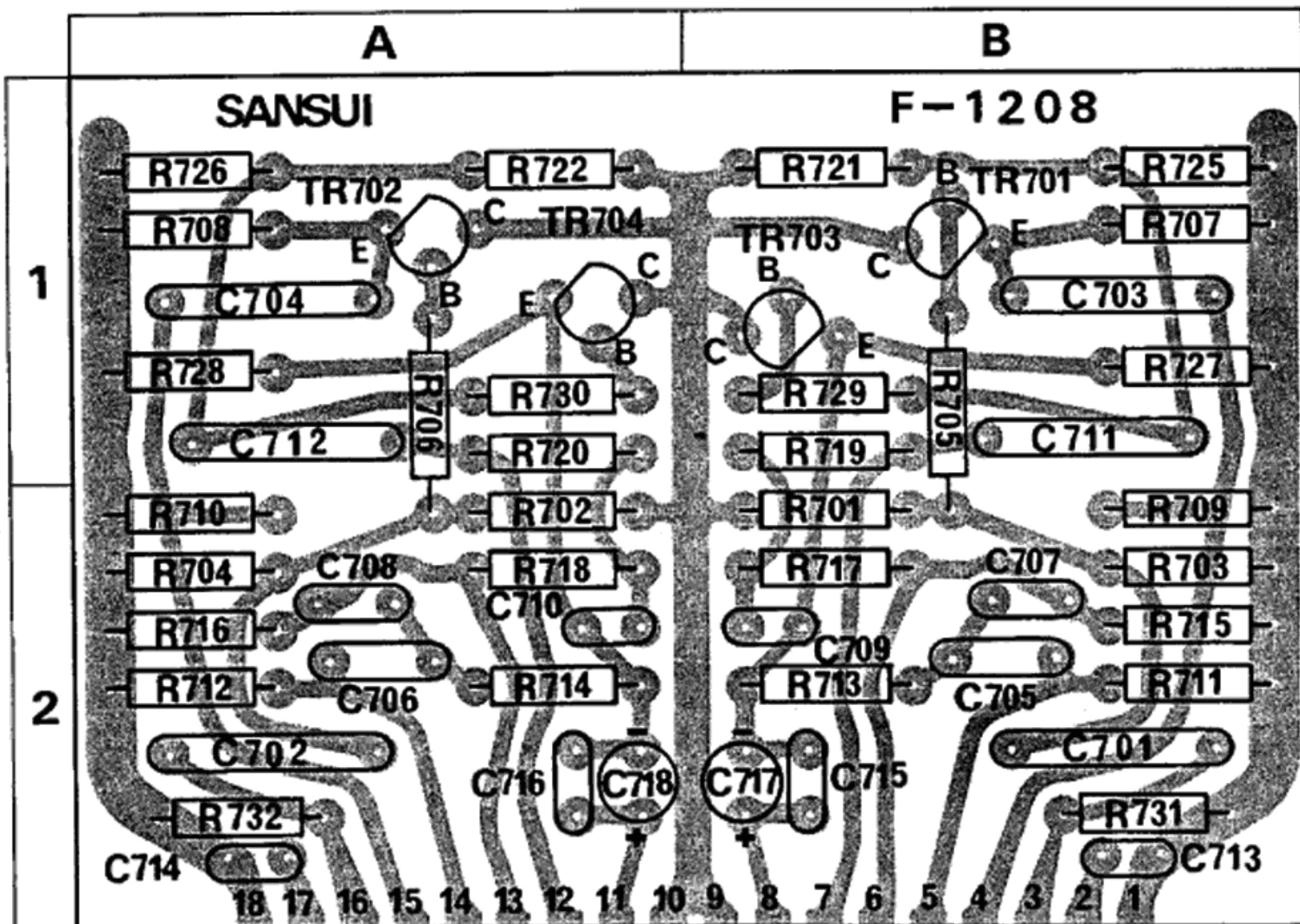

PRINTED CIRCUIT BOARDS AND PARTS LIST

RIPPLE FILTER BLOCK <F-1230>

X	Y	Z
R003	68Ω ±10% 3W Cement Resistor	1 B
R004	33kΩ ±10% ½W Solid Resistor	1 A
R005	8.2kΩ ±10% ½W Solid Resistor	1 A
R006	820Ω ±10% ½W Solid Resistor	1 A
C006	220μF 50 WV Electrolytic Capacitor	1 B
C007	220μF 50 WV Electrolytic Capacitor	1 A
C008	100μF 50 WV Electrolytic Capacitor	1 A
C009	100μF 50 WV Electrolytic Capacitor	1 A
C010	220μF 50 WV Electrolytic Capacitor	1 B
C011	0.01μF ±10% 50 WV Ceramic Capacitor	1 A
D002	10DC1R Silicon Diode (031067)	1 B
TR001	2SD223 (Y, G) Silicon Transistor (030823-1, 2)	1 A

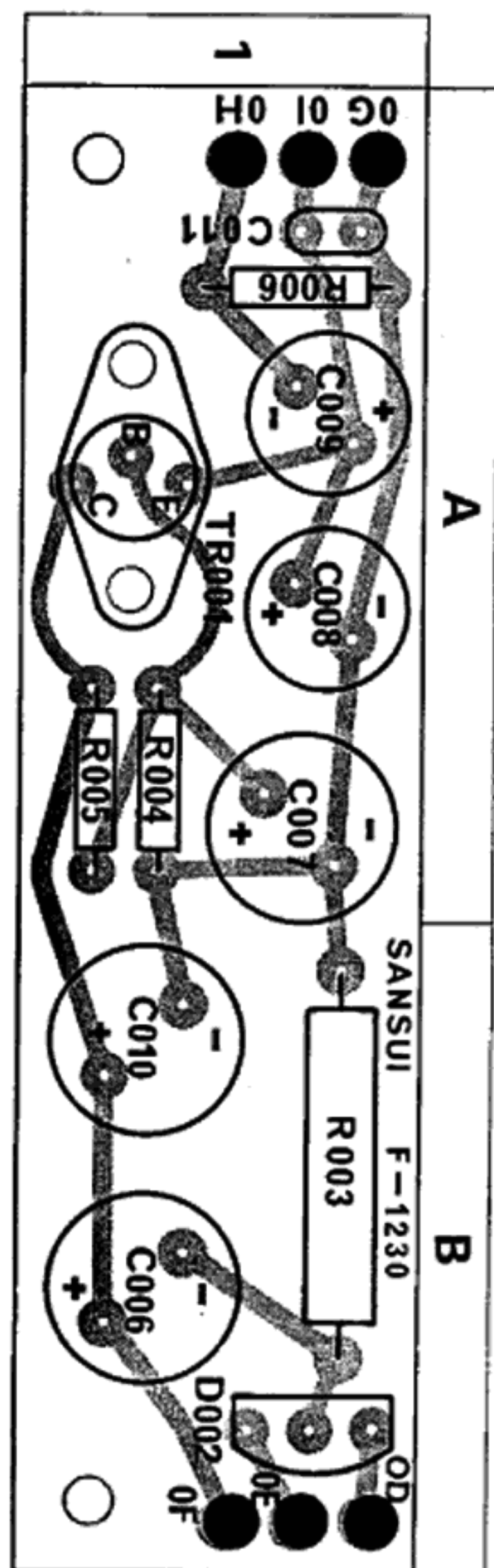

SP PROTECTOR BLOCK <F-1334>

X	Y	Z	
R901	10kΩ	B	
R902	10kΩ	A	
R903	3.9kΩ	B	
R904	3.9kΩ	A	
R905	560Ω	±10% ¼W Carbon Resistor	
R906	470Ω		
R907	150Ω	B	
R908	120Ω	A	
R910	150Ω	A	
C901	0.02μF	±80% 25V Ceramic Capacitor	
C902	0.02μF		
C903	220μF	±30% 10V BP. Electrolytic Capacitor	
TR901	2SC875 (E)	0305981	B
TR902	2SA532 (E)	0300371	A
D901	10DC-1R	0310670	B
D902	10DC-1N	0310680	A
D903	SR1FM-2	0310870	B
D904		0310870	A
SCR901	1RC5	0350050	B
SCR902		0350050	A

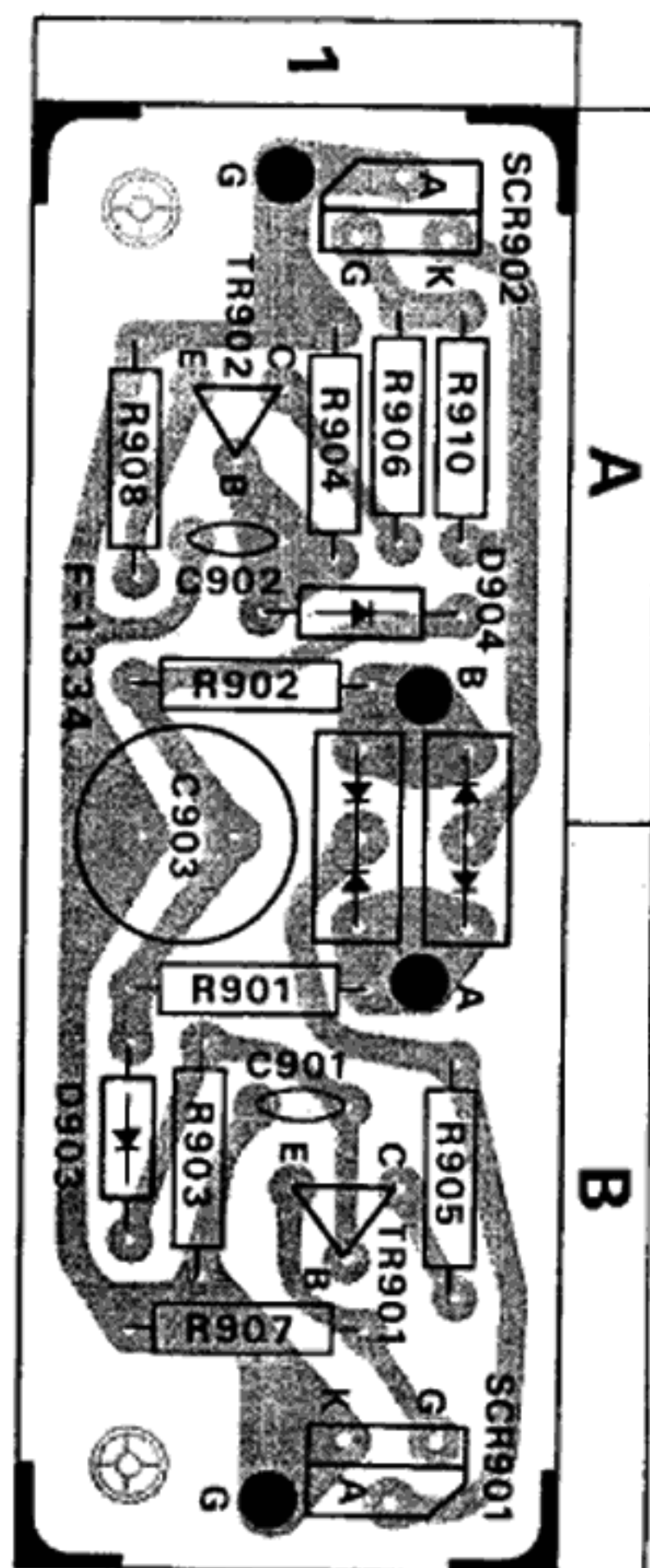

MINUS RIPPLE FILTER BLOCK <F-1277>

X	Y	Z
R854	0.5Ω ±20% 3W Cement Resistor	1A
R856	0.5Ω ±20% 3W Cement Resistor	1B
R858	4.7Ω ±10% 2W Cement Resistor	1A
R872	10kΩ ±10% ½W Solid Resistor	1B
R874	47Ω ±10% ½W Solid Resistor	1A
C814	100μF 50 WV Electrolytic Capacitor	1B
C816	4.7μF 50 WV Electrolytic Capacitor	1A
C818	0.01μF ±10% 50 WV Ceramic Capacitor	1A
C820	0.15μF ±10% 50 WV Ceramic Capacitor	1A
TR824	2SA532 (E) Silicon Transistor 0300371	1B

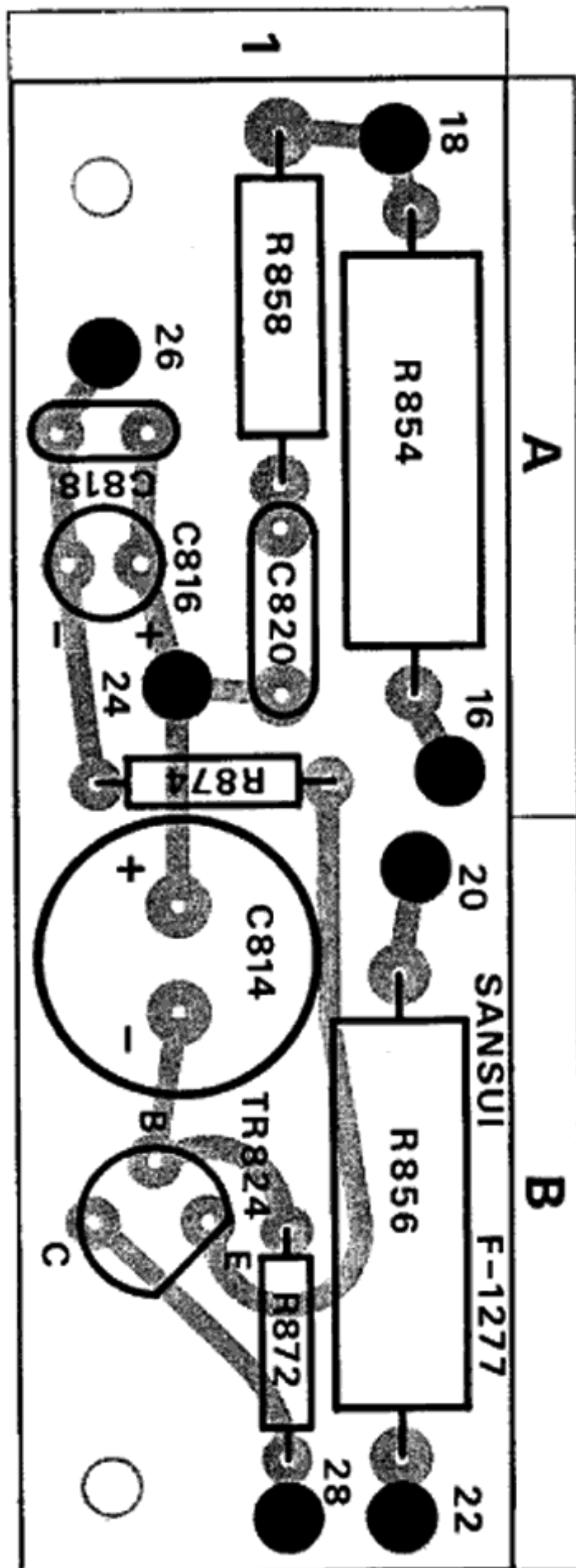

PLUS RIPPLE FILTER BLOCK <F-1231>

X	Y	Z
R853	0.5Ω ±20% 3W Cement Resistor	1A
R855	0.5Ω ±20% 3W Cement Resistor	1B
R857	4.7Ω ±10% 2W Cement Resistor	1A
R871	4.7kΩ ±10% ½W Solid Resistor	1B
R873	47Ω ±10% ½W Solid Resistor	1A
C813	100μF 50 WV Power Capacitor	1B
C815	4.7μF 50 WV Power Capacitor	1A
C817	0.01μF ±10% 50 WV Ceramic Capacitor	1A
C819	0.15μF ±10% 50 WV Mylar Capacitor	1A
TR823	2SC875 (E) Silicon Transistor 0305981	1B

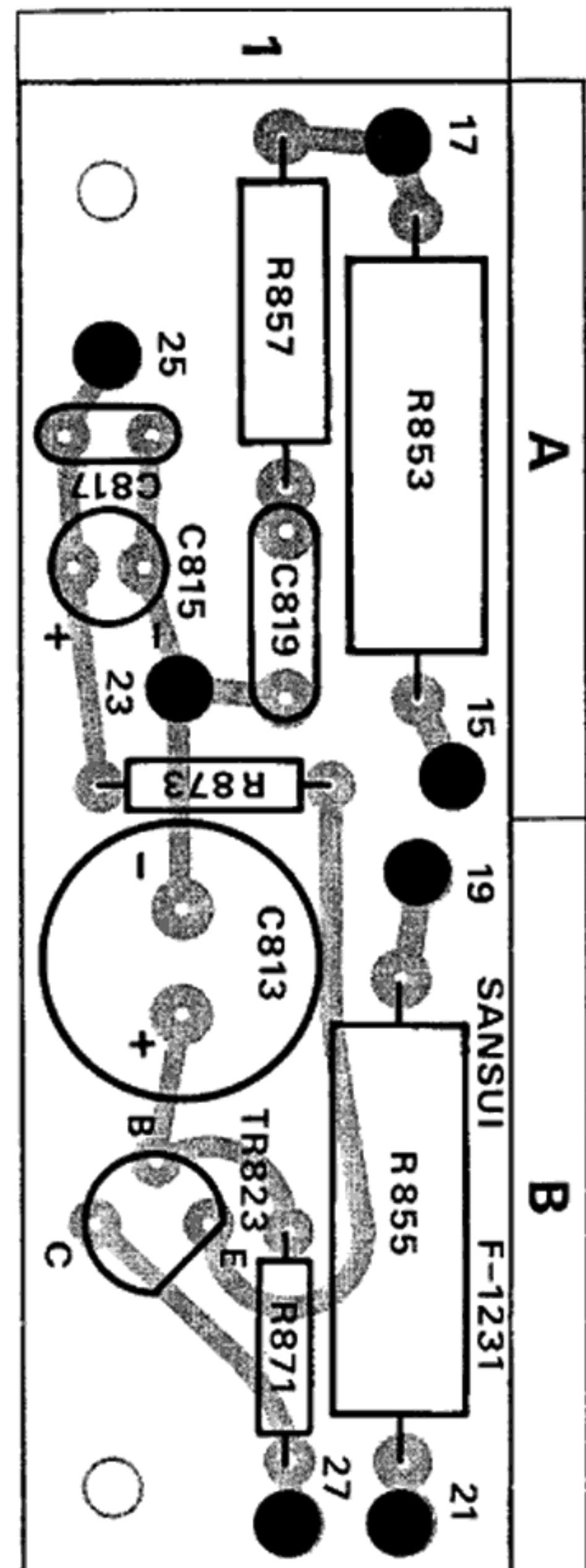

OTHER PARTS

X	Y
R635	100kΩ ±10% ¼W Carbon Resistor (R)
R636	100kΩ ±10% ¼W Carbon Resistor (R)
R637	100kΩ ±10% ¼W Carbon Resistor (R)
R638	100kΩ ±10% ¼W Carbon Resistor (R)
R639	100kΩ ±10% ¼W Carbon Resistor (R)
R640	100kΩ ±10% ¼W Carbon Resistor (R)
R641	100kΩ ±10% ¼W Carbon Resistor (R)
R642	100kΩ ±10% ¼W Carbon Resistor (R)
R643	47kΩ ±10% ¼W Carbon Resistor (R)
R644	47kΩ ±10% ¼W Carbon Resistor (R)
R645	56kΩ ±10% ¼W Carbon Resistor (R)
R646	56kΩ ±10% ¼W Carbon Resistor (R)
R647	100kΩ ±10% ¼W Carbon Resistor (R)
R648	100kΩ ±10% ¼W Carbon Resistor (R)
R649	330kΩ ±10% ¼W Carbon Resistor (R)
R650	330kΩ ±10% ¼W Carbon Resistor (R)
R723	3.3kΩ ±10% ¼W Carbon Resistor (R)
R724	3.3kΩ ±10% ¼W Carbon Resistor (R)
R733	820kΩ ±10% ¼W Carbon Resistor (R)
R734	820kΩ ±10% ¼W Carbon Resistor (R)
R777	6.8kΩ ±10% ¼W Carbon Resistor (R)
R778	6.8kΩ ±10% ¼W Carbon Resistor (R)
R779	8.2kΩ ±10% ¼W Carbon Resistor (R)
R780	8.2kΩ ±10% ¼W Carbon Resistor (R)
R781	10kΩ ±10% ¼W Carbon Resistor (R)
R782	10kΩ ±10% ¼W Carbon Resistor (R)
R783	10kΩ ±10% ¼W Carbon Resistor (R)
R784	10kΩ ±10% ¼W Carbon Resistor (R)
R785	12kΩ ±10% ¼W Carbon Resistor (R)
R786	12kΩ ±10% ¼W Carbon Resistor (R)
R787	12kΩ ±10% ¼W Carbon Resistor (R)
R788	12kΩ ±10% ¼W Carbon Resistor (R)
R789	10kΩ ±10% ¼W Carbon Resistor (R)
R790	10kΩ ±10% ¼W Carbon Resistor (R)
R791	10kΩ ±10% ¼W Carbon Resistor (R)
R792	10kΩ ±10% ¼W Carbon Resistor (R)
R793	8.2kΩ ±10% ¼W Carbon Resistor (R)
R794	8.2kΩ ±10% ¼W Carbon Resistor (R)
R795	6.8kΩ ±10% ¼W Carbon Resistor (R)
R796	6.8kΩ ±10% ¼W Carbon Resistor (R)
R797	4.7kΩ ±10% ¼W Carbon Resistor (R)
R798	4.7kΩ ±10% ¼W Carbon Resistor (R)
R799	6.8kΩ ±10% ¼W Carbon Resistor (R)
R7110	6.8kΩ ±10% ¼W Carbon Resistor (R)
R7111	8.2kΩ ±10% ¼W Carbon Resistor (R)
R7112	8.2kΩ ±10% ¼W Carbon Resistor (R)
R7113	10kΩ ±10% ¼W Carbon Resistor (R)
R7114	10kΩ ±10% ¼W Carbon Resistor (R)
R7115	10kΩ ±10% ¼W Carbon Resistor (R)
R7116	10kΩ ±10% ¼W Carbon Resistor (R)
R7117	10kΩ ±10% ¼W Carbon Resistor (R)
R7118	10kΩ ±10% ¼W Carbon Resistor (R)
R7119	6.8kΩ ±10% ¼W Carbon Resistor (R)
R7120	6.8kΩ ±10% ¼W Carbon Resistor (R)
R7121	5.6kΩ ±10% ¼W Carbon Resistor (R)
R7122	5.6kΩ ±10% ¼W Carbon Resistor (R)
R7123	3.9kΩ ±10% ¼W Carbon Resistor (R)

X	Y
R7124	3.9kΩ ±10% ¼W Carbon Resistor (R)
R7125	3.3kΩ ±10% ¼W Carbon Resistor (R)
R7126	3.3kΩ ±10% ¼W Carbon Resistor (R)
R7127	3.3kΩ ±10% ¼W Carbon Resistor (R)
R7128	3.3kΩ ±10% ¼W Carbon Resistor (R)
R7129	3.9kΩ ±10% ¼W Carbon Resistor (R)
R7130	3.9kΩ ±10% ¼W Carbon Resistor (R)
R7131	3.9kΩ ±10% ¼W Carbon Resistor (R)
R7132	3.9kΩ ±10% ¼W Carbon Resistor (R)
R7133	3.9kΩ ±10% ¼W Carbon Resistor (R)
R7134	3.9kΩ ±10% ¼W Carbon Resistor (R)
R7135	3.9kΩ ±10% ¼W Carbon Resistor (R)
R7136	3.9kΩ ±10% ¼W Carbon Resistor (R)
R7137	3.9kΩ ±10% ¼W Carbon Resistor (R)
R7138	3.9kΩ ±10% ¼W Carbon Resistor (R)
R7139	3.9kΩ ±10% ¼W Carbon Resistor (R)
R7140	3.9kΩ ±10% ¼W Carbon Resistor (R)
R7141	3.3kΩ ±10% ¼W Carbon Resistor (R)
R7142	3.3kΩ ±10% ¼W Carbon Resistor (R)
R7143	2.7kΩ ±10% ¼W Carbon Resistor (R)
R7144	2.7kΩ ±10% ¼W Carbon Resistor (R)
R7145	2.7kΩ ±10% ¼W Carbon Resistor (R)
R7146	2.7kΩ ±10% ¼W Carbon Resistor (R)
R7147	8.2kΩ ±10% ¼W Carbon Resistor (R)
R7148	8.2kΩ ±10% ¼W Carbon Resistor (R)
R7149	820kΩ ±10% ¼W Carbon Resistor (R)
R7150	820kΩ ±10% ¼W Carbon Resistor (R)
R7151	820kΩ ±10% ¼W Carbon Resistor (R)
R7152	820kΩ ±10% ¼W Carbon Resistor (R)
R7153	820kΩ ±10% ¼W Carbon Resistor (R)
R7154	820kΩ ±10% ¼W Carbon Resistor (R)
R7155	820kΩ ±10% ¼W Carbon Resistor (R)
R7156	820kΩ ±10% ¼W Carbon Resistor (R)
R7157	820kΩ ±10% ¼W Carbon Resistor (R)
R7158	820kΩ ±10% ¼W Carbon Resistor (R)
R7159	2.2kΩ ±10% ¼W Carbon Resistor (R)
R7160	2.2kΩ ±10% ¼W Carbon Resistor (R)
R7161	8.2kΩ ±10% ¼W Carbon Resistor (R)
R7162	8.2kΩ ±10% ¼W Carbon Resistor (R)
R7163	820kΩ ±10% ¼W Carbon Resistor (R)
R7164	820kΩ ±10% ¼W Carbon Resistor (R)
R859	470Ω ±10% 2W Metal Resistor (RD)
R860	470Ω ±10% 2W Metal Resistor (RD)
VR601, 602	200kΩ B × 2 PHONO 1 Level Adjustor (I 01503)
VR603, 604	200kΩ B × 2 PHONO 2 Level Adjustor (I 01503)
VR605, 606	200kΩ B × 2 AUX Level Adjustor (I 01503)
VR701, 702	250kΩ A, C Balance Volume (I 01045)
VR703, 704	250kΩ A × 2 Volume (I 01044)
C001	0.033μF 600 WV Oil Capacitor
C002	4700μF 50 WV Electrolytic Capacitor
C003	4700μF 50 WV Electrolytic Capacitor
C739	0.022μF ±10% 50 WV Mylar Capacitor
C740	0.022μF ±10% 50 WV Mylar Capacitor
C741	0.01μF ±10% 50 WV Mylar Capacitor
C742	0.01μF ±10% 50 WV Mylar Capacitor
C743	0.0022μF ±10% 50 WV Mylar Capacitor

X	Y	
C744	0.0022 μ F \pm 10% 50 WV Mylar Capacitor	
C745	0.0022 μ F \pm 10% 50 WV Mylar Capacitor	
C746	0.0022 μ F \pm 10% 50 WV Mylar Capacitor	
C747	0.1 μ F \pm 10% 50 WV Mylar Capacitor	
C748	0.1 μ F \pm 10% 50 WV Mylar Capacitor	
C749	0.1 μ F \pm 10% 50 WV Mylar Capacitor	
C750	0.1 μ F \pm 10% 50 WV Mylar Capacitor	
C751	0.1 μ F \pm 10% 50 WV Mylar Capacitor	
C752	0.1 μ F \pm 10% 50 WV Mylar Capacitor	
C754	0.1 μ F \pm 10% 50 WV Mylar Capacitor	
D001	5B2 Silicon Diode	(031066)
D905	SV-05 Silicon Diode	(031086)
D906	SV-05 Silicon Diode	(031086)
D907	SV-05 Silicon Diode	(031086)
D908	SV-05 Silicon Diode	(031086)
TR815	2SC680 Silicon Transistor	(030562-0~2)
TR816	2CS680 Silicon Transistor	(030562-0~2)
TR817	2SA566 Silicon Transistor	(030015-0~2)
TR818	2SA566 Silicon Transistor	(030015-0~2)
TR819	2SC898 Silicon Transistor	(030570-0,1)
TR820	2SC898 Silicon Transistor	(030570-0,1)
TR821	2SC898 Silicon Transistor	(030570-0,1)
TR822	2SC898 Silicon Transistor	(030570-0,1)
PL001	6.3V 250mA Pilot Lamp	(040009)
PL002	7V 200mA Pilot Lamp	(040015-2)
PL003	7V 200mA Pilot Lamp	(040015-0)
PL004	7V 200mA Pilot Lamp	(040015-2)
PL005	7V 200mA Pilot Lamp	(040015-1)
PL006	7V 200mA Pilot Lamp	(040015-0)
T001	Power Transformer (400-5368)	(400058)
F001~006	5A Quick Acting Fuse	(043014)
F007	4A Fuse	(043005)
CO001	AC Outlet	(245001-1)
CO002	AC Outlet	(245001-1)
CO005	AC Outlet	(245001-1)
PU601	5P Connector (DIN)	(243004)
J801	Headphones Jack	(243007-1)
J601, 602	2P64M Jack	(243008-1)
S1(a~g)	SOURCE Selector Switch (1)	(110413)
S2(a~c)	SOURCE Selector Switch (2)	(117010)
S3(a~d)	Tape to Tape Switch	(117010)
S4(a, b)	Tape Monitor Switch	(117014)
S5(a, b)	Pickup Load Switch	(111011)
S6(a~c)	Mode Switch	(110119)
S7(a, b)	Low Filter Switch	(117012)
S8(a, b)	High Filter Switch	(117012)
S9(a, b)	Tone Control Switch (Midrange)	(110212)
S10(a, b)	Midrange Selector Switch	(110120)
S11(a, b)	Tone Control Switch (Treble)	(110212)
S12(a, b)	Treble Selector Switch	(110120)
S13(a, b)	Tone Control Switch (Bass)	(110212)
S14(a, b)	Bass Selector Switch	(110120)
S15(a, b)	Muting Switch	(117012)
S16(a~f)	Speaker Selector Switch	(110325)

X	Y	
S17(a, b)	Balance Check Switch	(117012)
S18(a, b)	Power Switch	(117011)

OTHER PARTS AND THEIR POSITION ON CHASSIS

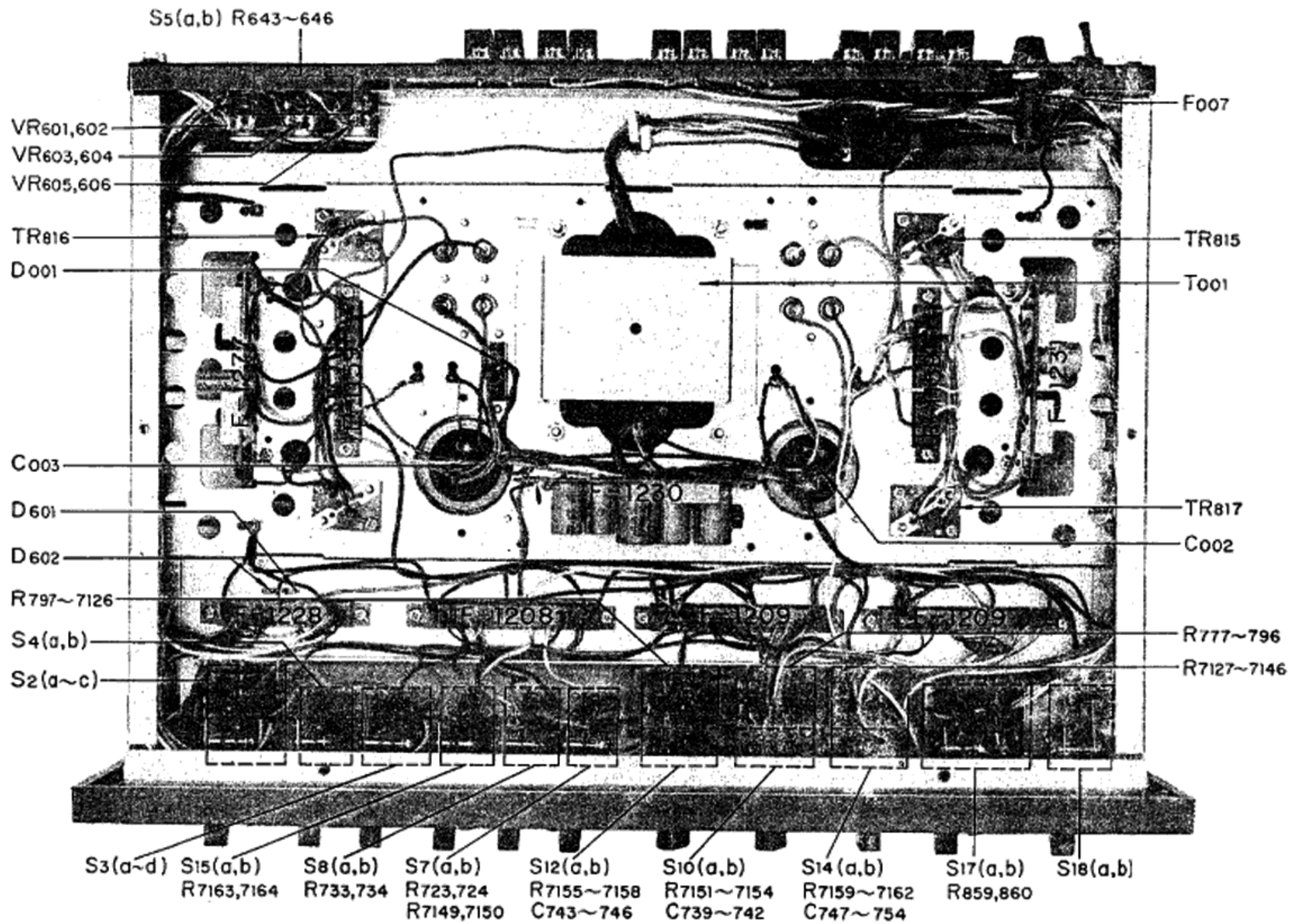

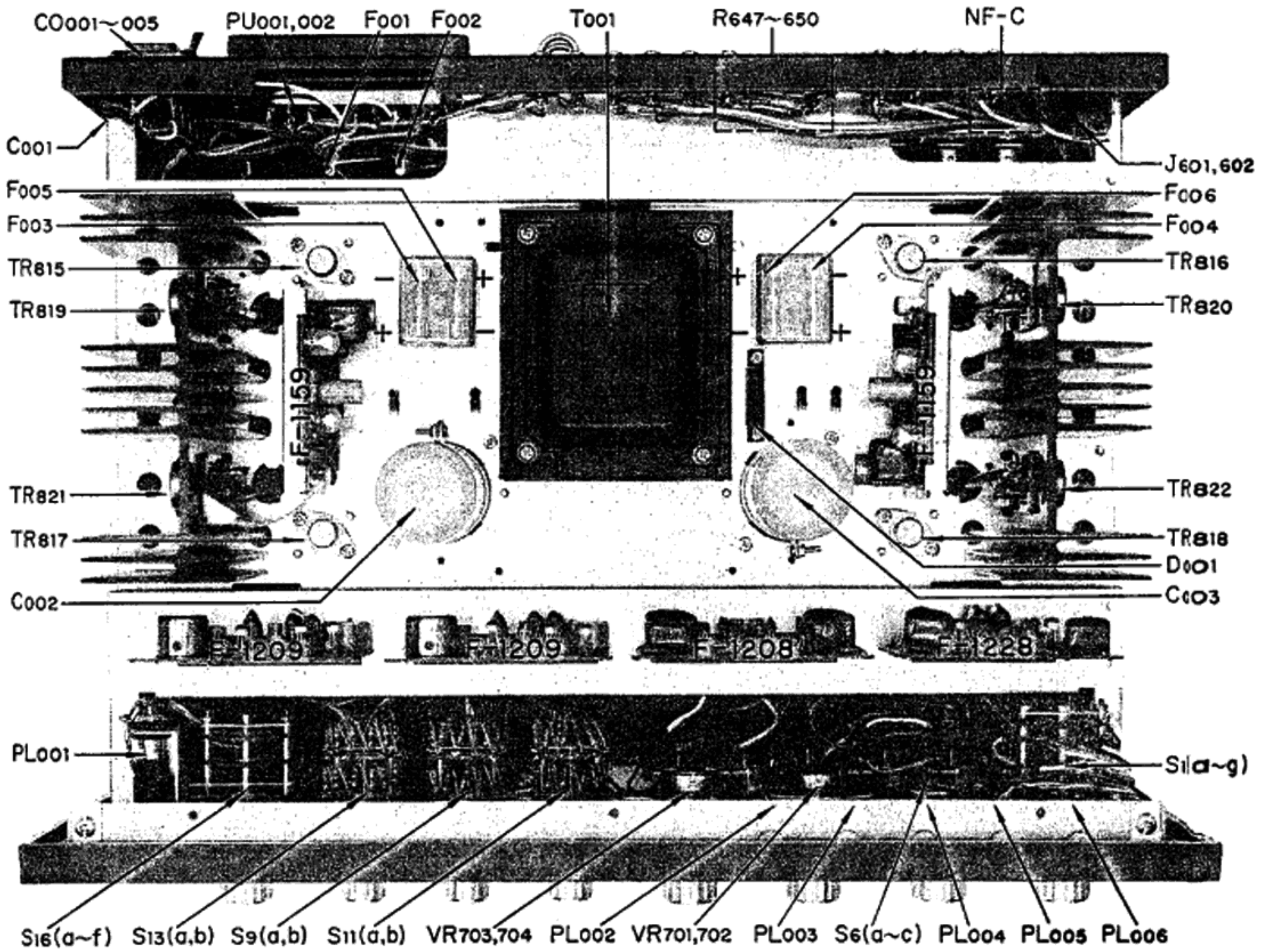



SANSUI ELECTRIC CO., LTD.

14-1, 2-chome, Izumi, Suginami-ku, Tokyo 168, Japan
TELEPHONE: (03) 323-1111/TELEX: 232-2076

Stock No. 9206810

Printed in Japan (S 3500M4)